



HYPERTHERMIA PUMP™

OPERATOR'S MANUAL



HYPERTHERMIA PUMP™

OPERATOR'S MANUAL



BELMONT[®]
MEDICAL
TECHNOLOGIES

All service calls & questions should be directed to:

USA: +1.855.397.4547
Worldwide: +1.978.663.0212



Belmont Medical Technologies
780 Boston Road
Billerica, MA 01821, USA

EC REP

CE 1434

Emergo Europe
Westervoortsedijk 60
6827 AT ARNHEM
The Netherlands
+31 (0) 70 345 8570

Hyperthermia Pump™

Operator's Manual

Table of Contents

| | |
|--|-----------|
| CHAPTER 1: SYSTEM OVERVIEW | 6 |
| INTRODUCTION | 6 |
| INDICATIONS FOR USE | 6 |
| CONTRAINDICATIONS | 7 |
| WARNINGS | 7 |
| OVERVIEW OF THE HYPERTHERMIA PUMP™ | 8 |
| CONTROL PANEL: DISPLAY AND KEYS..... | 9 |
| VACUUM REGULATOR..... | 10 |
| ORDERING INFORMATION | 11 |
| CHAPTER 2: OPERATION | 12 |
| INTRODUCTION | 12 |
| STEP-BY-STEP SUMMARY OF OPERATING PROCEDURES | 12 |
| <i>IV POLE MOUNTING</i> | <i>12</i> |
| <i>INSPECT THE SYSTEM.....</i> | <i>13</i> |
| <i>INSTALLING DISPOSABLE SET.....</i> | <i>14</i> |
| <i>INSTALL 4.4 LITER RESERVOIR AND THE STRAIGHT INFLOW/OUTFLOW PATIENT LINE</i> | <i>15</i> |
| <i>INSTALL 4.4 LITER RESERVOIR AND THE STRAIGHT INFLOW/ BIFURCATED OUTFLOW PATIENT LINE.....</i> | <i>16</i> |
| <i>INSTALL 4.4 LITER RESERVOIR AND THE STRAIGHT INFLOW/OUTFLOW WITH (2) SUMPS AND (2) VIAGUARDS PATIENT LINE</i> | <i>17</i> |
| <i>POWER ON.....</i> | <i>18</i> |
| <i>CHANGE LANGUAGE</i> | <i>19</i> |
| <i>INSTALLING FLUID BAG AND PRIME.....</i> | <i>19</i> |
| <i>PRIME THE MAINE SYSTEM.....</i> | <i>20</i> |
| <i>PRIME THE PATIENT LINE.....</i> | <i>20</i> |
| <i>CONNECT EXTERNAL TEMPERATURE PROBES.....</i> | <i>21</i> |
| <i>CONNECT TO THE PATIENT.....</i> | <i>21</i> |
| <i>INITIATING HYPERTHERMIC LAVAGE.....</i> | <i>22</i> |
| <i>MAINTAIN HYPERTHERMIC LAVAGE</i> | <i>23</i> |
| <i>END OF PROCEDURE</i> | <i>24</i> |
| <i>ACCIDENTAL POWER OFF.....</i> | <i>25</i> |
| <i>BATTERY OPERATION SCREEN.....</i> | <i>25</i> |
| CHAPTER 3: ALARMS AND TROUBLESHOOTING GUIDE | 26 |
| INTRODUCTION | 26 |
| A. OPERATIONAL ALARMS:..... | 26 |
| <i>AIR DETECTION</i> | <i>26</i> |
| <i>DOOR OPEN.....</i> | <i>27</i> |

| | |
|---|-----------|
| FLUID OUT | 27 |
| HIGH PRESSURE | 28 |
| MISSING DISPOSABLE | 28 |
| B. HEATING ALARMS | 28 |
| SYSTEM ERROR #101 | 28 |
| SYSTEM ERROR #102 | 29 |
| C. HARDWARE ALARMS | 29 |
| SYSTEM ERROR #201 | 29 |
| SYSTEM ERROR #202 | 29 |
| SYSTEM ERROR #203 | 29 |
| SYSTEM ERROR #204 | 29 |
| SYSTEM ERROR #205 | 29 |
| SYSTEM ERROR #206 | 30 |
| SYSTEM ERROR #207 | 30 |
| SYSTEM ERROR #208 | 30 |
| SYSTEM ERROR #209 | 30 |
| SYSTEM ERROR #210 | 30 |
| D. TROUBLESHOOTING OTHER OPERATIONAL DIFFICULTIES | 31 |
| CHAPTER 4: PARAMETERS SETTING AND PREVENTIVE MAINTENANCE | 33 |
| INTRODUCTION | 33 |
| A. SYSTEM SETUP | 34 |
| 1. Date/Time | 35 |
| 2. Display Brightness | 36 |
| 3. Language Setup..... | 36 |
| 4. Key Rate | 36 |
| 5. Pressure Limit..... | 36 |
| B. SERVICE AND PREVENTIVE MAINTENANCE SCHEDULE | 37 |
| Schedule 1 | 37 |
| Schedule 2 | 37 |
| C. ROUTINE MAINTENANCE..... | 38 |
| 1. Clean and/or Disinfect Exterior | 38 |
| 2. Fluid Out and In-Line Air Detectors | 38 |
| 3. Power Cord | 38 |
| 4. Temperature Probes | 38 |
| 5. Fan Guards | 38 |
| 6. Vacuum trap..... | 38 |
| 7. Seals | 39 |
| 8. Instrument Door and Ceramic Disks..... | 39 |
| 9. Rubber Feet | 39 |
| D. TEST/SYSTEM OPERATIONAL CHECK-OUT | 40 |
| 1. Visual Inspection..... | 40 |

| | |
|--|-----------|
| 2. <i>System Operational Check-Out</i> | 41 |
| 3. <i>Electrical Safety Test - Leakage Current</i> | 41 |
| 4. <i>Hardware Verification</i> | 43 |
| 5. <i>Clean Pump Head</i> | 48 |
| E. CHECKLIST | 49 |
| F. ELECTROMAGNETIC COMPATIBILITY | 51 |
| G. FUSE | 53 |
| H. CALL FOR SERVICE..... | 53 |
| CHAPTER 5: TECHNICAL SPECIFICATIONS | 54 |
| DIMENSIONS | 54 |
| PORTABILITY | 54 |
| POWER AC | 54 |
| BATTERY TYPE..... | 54 |
| ENVIRONMENTAL..... | 55 |
| OPERATING PARAMETERS | 55 |
| OPERATING PANEL..... | 55 |
| SAFETY AND MONITORING | 56 |
| ALARM STATES AND CONTROLS | 56 |
| CLASSIFICATIONS..... | 57 |
| SYMBOLS AND DEFINITIONS..... | 57 |
| WASTE ELECTRICAL AND ELECTRONIC EQUIPMENT (WEEE) | 58 |

CHAPTER 1: SYSTEM OVERVIEW

INTRODUCTION



The system must be operated by knowledgeable users. It is essential that you read and understand this manual before operating the system.

The Hyperthermia Pump™ is used in therapeutic procedures to raise the temperature of the thoracic or peritoneal cavity to the desired target temperature by continuously lavaging the cavity with warmed sterile solution. The warmed sterile solution is pumped into a body cavity, withdrawn, reheated, and recirculated back to the body cavity for a period of time specified by the physician.

The system monitors sterile solution temperature, line pressure, and air in the fluid path to ensure safe operation and alarms at all unsafe conditions. A total of four (4) sterile temperature probes are supplied as part of Hyperthermia Pump™ Procedure Kit (REF 902-00045). Two (2) of the temperature probes are fixed within the fluid path line to accurately monitor the temperature of fluid input and output. The other two (2) temperature probes are supplied as part of the Hyperthermia Pump™ Procedure Kit, (REF 902-00045) for optional use with the location to be determined by the physician. The use of temperature probes is optional. Temperature probes do not interface with the unit's control system, their purpose is to provide data for display only.

A touch screen displays flow rate, total fluid pumped, output temperature, patient temperature (4 locations), line pressure, alarm and status messages and proper procedures to proceed safely after an alarm situation. Keys appropriate to a particular point in the operation are displayed on the touch screen. A hardware override circuit prevents unsafe operation in case of system computer failure. A vacuum regulator is provided to allow regulation of the fluid levels of the large reservoir and in turn regulates fluid levels in the patient body.

A battery backup ensures uninterrupted operation, for a very short period of time, when the AC power is disconnected. An audible alarm sounds, after 10 seconds, to alert the user that the system is in battery operation and action is required. If the AC power is not restored, the system shuts down after 90 seconds. **There is no heat in battery operation.**

Disclaimer: Proper surgical procedures and techniques are the responsibility of the medical profession. The described procedure is furnished for information purposes only. Each surgeon must evaluate the appropriateness of the procedure being used based on their own medical training and experience and the type of surgical procedure being performed.

INDICATIONS FOR USE

- To raise the temperature of the thoracic or peritoneal cavity to the desired target temperature by continuously lavaging the cavity with circulating warmed sterile solution, according to a protocol to be selected by the physician.

CONTRAINDICATIONS

- The Hyperthermia Pump™ is **not** for use in warming blood, or blood components, or blood products for the purpose of transfusion.

WARNINGS



- For use by trained professional only. The Hyperthermia Pump should not be left unattended while in operation.
- Do not use this product in the presence of flammable anesthetics.
- To avoid risk of electric shock, supply interruption and for proper functionality this device must only be connected to a dedicated supply main with protective earth. **Use a dedicated circuit breaker for AC power supply.**
- Do not use this product in an Oxygen rich environment.
- Do not use this product in the presence of Nitrous oxide.
- Do not use with pressure infusers or “bag squeezers”. The system pump provides adequate pressure to infuse fluid.
- The Hyperthermia Pump™ is **not** for use in warming blood, or blood components, or blood products for the purpose of transfusion.
- The Hyperthermia Pump™ has not been evaluated for the delivery of chemotherapeutic agents.
- Immediately wipe any spills from device.

OVERVIEW OF THE HYPERTHERMIA PUMP™

The complete system consists of the Control System, which is mounted on an IV pole, and the System Disposable Set. The Hyperthermia Pump™ can be used only with the supplied disposables. The Disposable Set is preconnected and has a sterile fluid path. It is intended for single patient use only.

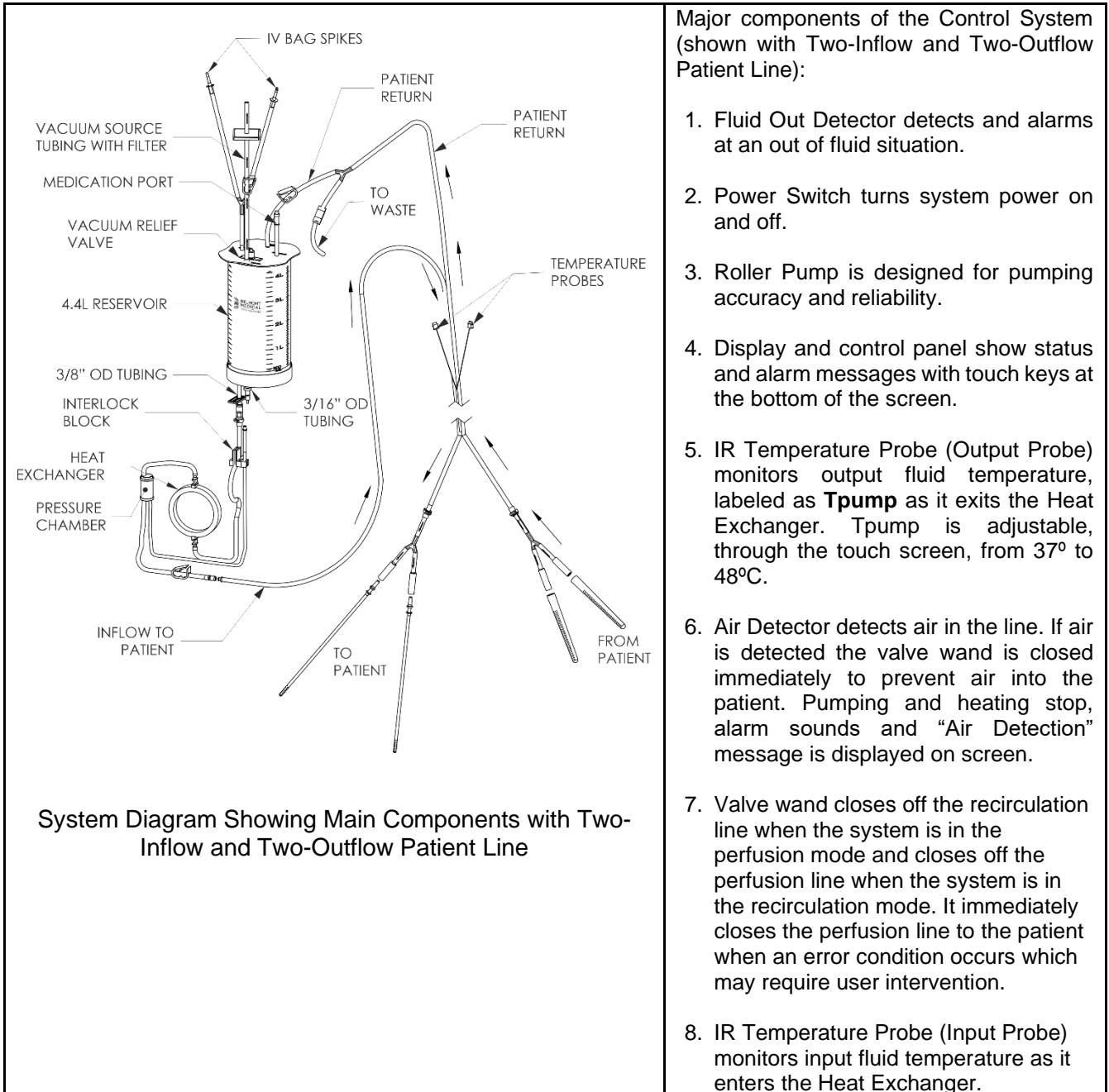

Chapter 1: System Operation

Three (3) disposable set options are available: Single Reservoir with Straight Inflow/Outflow (page 3), Single Reservoir with Straight Inflow/Bifurcated Outflow Patient Line (page 3), and Single Reservoir with two-Inflow and two-Outflow Patient Line (page 2).

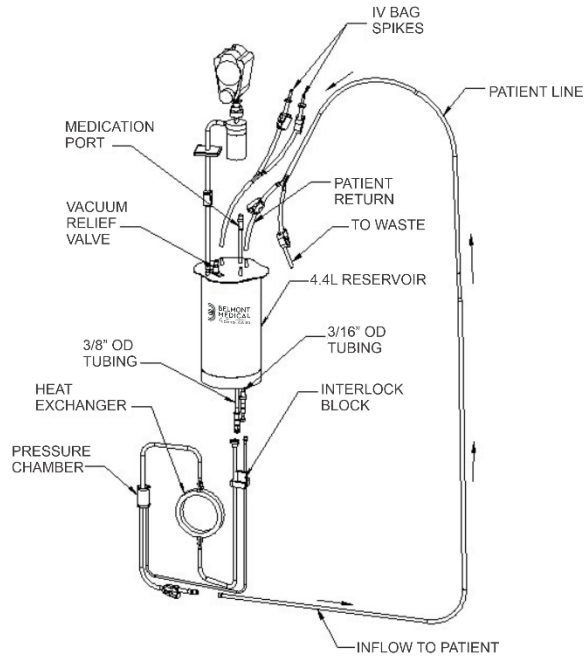

Single Reservoir, 4.4 Liter, with Straight Inflow/Straight Outflow Patient Line

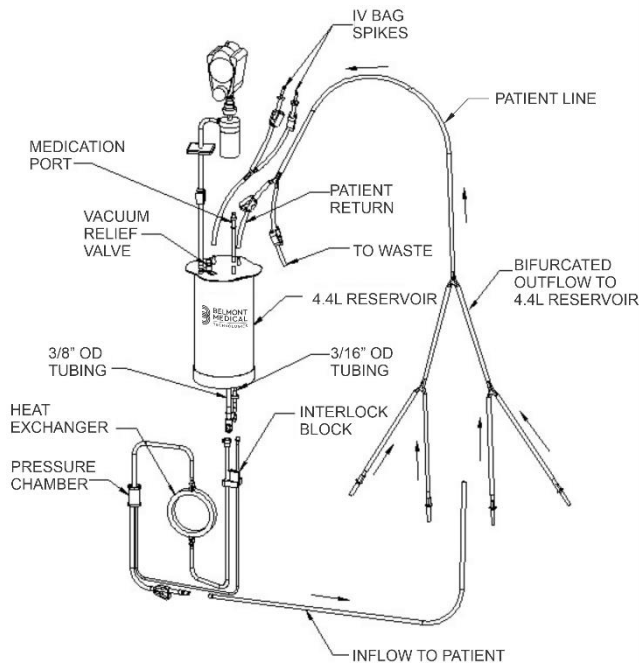

Single Reservoir, 4.4 Liter, with Straight Inflow/Bifurcated Outflow Patient Line

CONTROL PANEL: DISPLAY AND KEYS

The control panel consists of the touch screen display, which incorporates a bright graphical display with touch pad keys. The display shows status and alarm messages at the top and middle and contains the touch keys at the bottom.

CONTROL PANEL SUMMARY

Status Display:

- **Flow Rate in ml/min**
- **Volume Infused, in liter**
- **Heated Fluid Temperature, T_{pump}, in °C**
- **Patient Temperature, T₁, in °C**
- **Patient Temperature, T₂, in °C**
- **Patient Temperature, T₃, in °C**
- **Patient Temperature, T₄, in °C**
- **Pressure in the Fluid Line in mmHg**
- **Target Temperature ▲ in °C**
- **Target Temperature ▼ in °C**

Function Keys: The keys that control all system functions are displayed on the screen. The screen is changed each time a function key is pressed. Only keys that are relevant to the desired function are presented. The active key is highlighted.

There are three (3) different levels of sensitivity: Fast, Medium, and Slow. The key sensitivity is set at the factory to medium but can be adjusted by the operator in SERVICE MODE.

See Chapter 4 for 'Key Rate' sensitivity setup.

Alarm Display: Graphical alarm messages indicating where errors have occurred and suggested operator action.

VACUUM REGULATOR

Display: 0 to -160 mmHg Analog gauge

Control: Multi-turn knob

| |
|-----------------------------|
| ORDERING INFORMATION |
|-----------------------------|

Hyperthermia Pump™ REF: 902-00001, 120 volt
(Pump plus accessory)

Hyperthermia Pump™ REF: 902-00001A, 230 volt
(Pump plus accessory)

Accessory Kit for Single Reservoir REF: 902-00013

Disposable Set Kit for 4.4 Liter Reservoir with Straight Inflow/Outflow Patient Line

REF: 902-00037 consists of:

- (1 set) Heat Exchanger REF: 902-00006P
- (1 set) 4.4 Liter Reservoir REF: 902-00034P
- (1 set) Straight Outflow Patient Line REF: 902-00039P

Disposable Set Kit for 4.4 Liter Reservoir with Straight Inflow/Bifurcated Outflow Patient Line

REF: 902-00038 consists of:

- (1 set) Heat Exchanger REF: 902-00006P
- (1 set) 4.4 Liter Reservoir REF: 902-00034P
- (1 set) Straight Inflow/Bifurcated Outflow Patient Line REF: 902-00040P

Disposable Set Kit for 4.4 Liter Reservoir with two-Inflow and two-Outflow Patient Line, the Hyperthermia Pump™ Procedure Kit,

REF: 902-00045 consists of:

- (1 set) Heat Exchanger REF: 902-00006P
- (1 set) 4.4 Liter Reservoir REF: 902-00034P
- (1 set) Patient Line with Cannula & Temperature Probes REF: 902-00048P

CHAPTER 2: OPERATION

INTRODUCTION

This chapter explains the procedure for setting up and initiating safe and effective operation of the Hyperthermia Pump™. To change screens' language, select language at start-up or go to Chapter 4 "LANGUAGE SETUP" to setup your preferred language.

STEP-BY-STEP SUMMARY OF OPERATING PROCEDURES

IV POLE MOUNTING

IV Pole: 5-wheel, maximum diameter 1 ¼"



CAUTION:

DISCLAIMER: THE IV POLE IS NOT REQUIRED FOR USE; IT IS NOT CONSIDERED CRITICAL-DETACHABLE COMPONENT AND ORDERING AN IV POLE FROM BELMONT IS OPTIONAL.

If an IV Pole is used, check that the system is securely clamped to the IV pole and will not tip over.

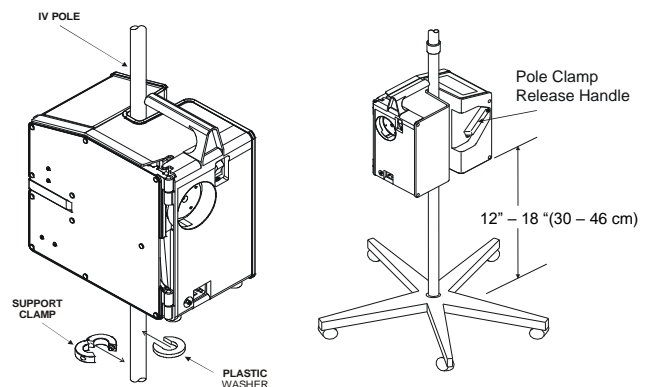

1. Install the support assembly (support clamp and washer) approximately 12" to 18" above the IV pole base.
 - While holding clamp closed, loosen the screw to open up the clamp. Install clamp on the IV pole, holding clamp closed and tighten screw using the supplied 3/16 Allen wrench.
 - Optional: Snap the plastic washer onto the IV pole above the support clamp. Not all IV Poles are supplied with the plastic washer as it is optional and does not affect functionality.

2. Lift up on the "Pole Clamp Release Handle" to open. Mount the system onto the IV pole, just above the support assembly, by pushing down on the pole clamp release handle. Check that the system is locked in place before proceeding.

3. Clamp the Reservoir Holder onto the IV pole above the Hyperthermia Pump™.

4. If used, clamp the Vacuum Trap Holder a few inches above the Reservoir Holder.

If the Vacuum Regulator, REF 403-00341, is used, screw the trap into the regulator then clamp this assembly a few inches above the Reservoir Holder.

- Make certain that there is nothing obstructing the air vents at the bottom of the system.

Chapter 2: Operation

| | |
|---|--|
| <p>INSPECT THE SYSTEM</p> <p>Inspect the system to ensure that you have all necessary components.</p> <p>External Temperature probes, not supplied in base unit. Make sure you have them, if needed.</p> <p>(4) Interface cables, supplied, are compatible with a variety of temperature sensor probes, i.e. Measurement Specialties Model 4491 disposable General Purpose Temperature Probe or DeRoyal REF 81-020409.</p> | <p><u>For 4.4 Liter Reservoir with Straight Outflow Kit, REF 902-00037:</u></p> <ul style="list-style-type: none"> ▪ (1) Power cord. Use only the supplied power cord. ▪ (4) External Temperature Interface Cables ▪ (1) Heat Exchanger, REF 902-00006P ▪ (1) 4.4 Liter Reservoir, REF 902-00034P, contains <ul style="list-style-type: none"> ○ (1) tubing with bag spike ○ (1) tubing with medication port ○ (1) Vacuum source tubing with filter ▪ (1) 16 ft. Patient Line Set, REF 902-00039P ▪ (1) Reservoir Holder, REF 403-00252 ▪ (1) Vacuum Regulator Assembly, REF 403-00341 Hospital supplied vacuum source capable of reaching -160 mmHg |
| <p>4.4 Liter Reservoir with Straight Inflow/Bifurcated Outflow Option</p> | <p><u>For 4.4 Liter Reservoir with Straight Inflow/Bifurcated Outflow Kit, REF 902-00038:</u></p> <ul style="list-style-type: none"> ▪ (1) Power cord. Use only the supplied power cord. ▪ (4) External Temperature Interface Cables ▪ (1) Heat Exchanger, REF 902-00006P ▪ (1) 4.4 Liter Reservoir, REF 902-00034P <ul style="list-style-type: none"> ○ (1) tubing with bag spike ○ (1) tubing with medication port ○ (1) Vacuum source tubing with filter ▪ (1) Patient Line Set, REF 902-00040P, contains <ul style="list-style-type: none"> ○ (1) 8 ft. Patient Line with straight inflow ○ (1) 8 ft. bifurcated outflow ▪ (1) Reservoir Holder, REF 403-00252 ▪ (1) Vacuum Regulator Assembly, REF 403-00341 Hospital supplied vacuum source capable of reaching -160 mmHg |
| <p>4.4 Liter Reservoir with two-Inflow and two-Outflow Patient Line Option</p> | <p><u>For Hyperthermia Pump™ Procedure Kit, REF 902-00045</u></p> <ul style="list-style-type: none"> ▪ (1) Power cord. Use only the supplied power cord. ▪ (4) External Temperature Interface Cables ▪ (1) Heat Exchanger, REF 902-00006P ▪ (1) 4.4 Liter Reservoir, REF 902-00034P <ul style="list-style-type: none"> ○ (1) tubing with bag spike ○ (1) tubing with medication port ○ (1) Vacuum source tubing with filter ▪ (1) Procedure Kit, REF 902-00048P, contains <ul style="list-style-type: none"> ○ (1) Multi-bore Patient Line with straight inflow/outflow and (2) temperature probes ○ (1) Y-connection with (2) Sumps ○ (1) Y-connection with (2) Viaguards ○ (2) Temperature Probes ▪ (1) Reservoir Holder, REF 403-00252 ▪ (1) Vacuum Regulator Assembly, REF 403-00341 ▪ Hospital supplied vacuum source capable of reaching -160 mmHg |

INSTALLING DISPOSABLE SET

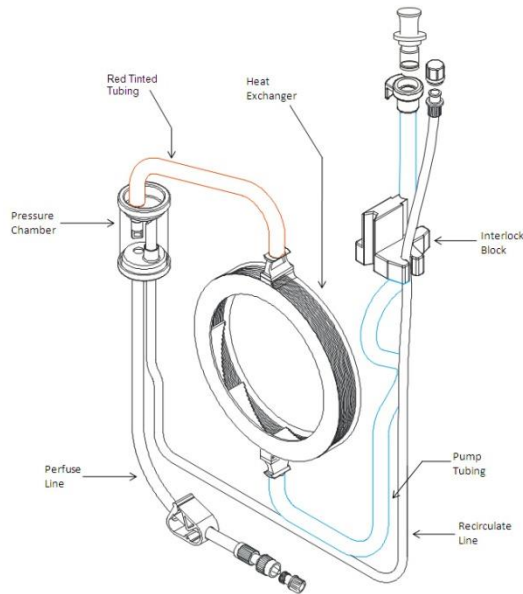

Heat Exchanger with key components



The disposable set is for single patient use only. Do not reuse.



DO NOT USE disposable set if package has been damaged or opened.

Store the disposable set in a dry well-ventilated area free from exposure to chemical vapors. Always apply first-in, first-out technique to minimize the length of storage of the sets.



1. Open the door. Insert Heat Exchanger with red arrow pointing up (**Red tinted tubing** to red stripe on unit.)

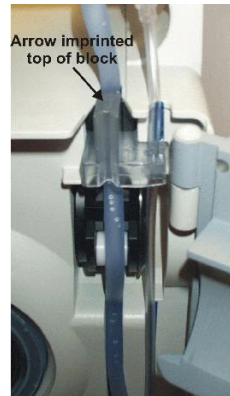

2. Firmly position the Interlock Block into the fluid out detector.
3. Guide the curved piece of pump tubing (**Blue tinted tubing**) over the pump head. Check that the thinner Recirculate Line (3/16" O.D tubing) is in the groove to the right.

Do not kink or twist the tubing.



4. Place the Pressure Chamber into the pressure chamber well. Firmly insert the wider Perfusion Line (3/8" O.D tubing) into the air detector and to the left of valve wand.

Do not apply excessive pressure to the pressure transducer. The pressure transducer can be damaged with excessive force. Do not use the system if the pressure transducer is damaged.

5. Place the thinner Recirculate Line (3/16" O.D tubing) to the right of the air detector, and to the right of the valve wand.
6. Close and latch the door. Make certain the pump tubing is not pinched.

INSTALL 4.4 LITER RESERVOIR AND THE STRAIGHT INFLOW/OUTFLOW PATIENT LINE

Straight Inflow/Outflow Patient Line Configuration with 4.4 Liter Reservoir, Heat Exchanger and Vacuum Regulator

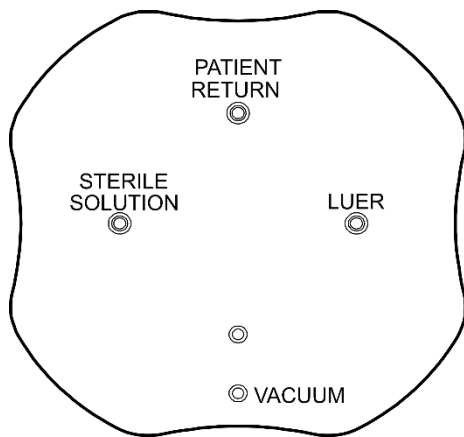
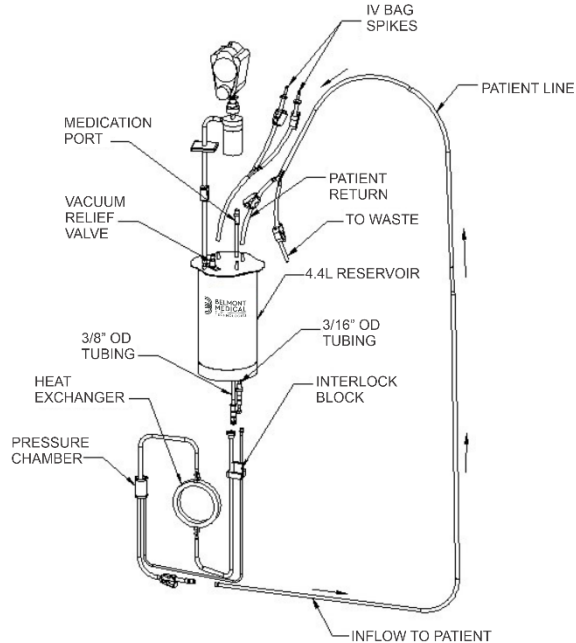

Reservoir Top View

4.4 Liter Reservoir with Straight Inflow/Outflow Patient Line Version

1. Place the reservoir into the holder.
2. Assemble the reservoir, using aseptic techniques, as follows:

Top of Reservoir: Remove all vented caps from top of reservoir and install these parts to the marked locations:

- Bag Spike for STERILE SOLUTION
- Tubing with injection port to LUER
- Regulator source tubing from the vacuum to VACUUM

3. Using aseptic technique, connect the Reservoir outlet, 3/8" O.D tubing, and the Recirculation Line, 3/16" O.D tubing, to the connectors of the Heat Exchanger.
4. Adjust the Reservoir Holder to make sure that the two connection leads underneath the reservoir are not stretched or kinked.

Stretched or kinked connection leads can cause flow restrictions.

5. Close all clamps and the ON/OFF pinch clamps.

INSTALLING PATIENT RETURN LINE

1. Hand off the 16 ft. Patient Return Line to the sterile field.
2. Receive both ends of the Patient Return Line from the sterile field.
3. Connect LUER end of the Patient Return Line to the LUER lock on the Heat Exchanger. Observe directional ARROW imprinted on the patient line.
4. Connect one "Y-Connection" end of the Patient Line to top of the reservoir, marked PATIENT RETURN. The other end is used to remove waste at the end of the procedure. **MAKE SURE THE ON/OFF PINCH CLAMP ON THIS LINE IS PINCHED CLOSED.**

INSTALL 4.4 LITER RESERVOIR AND THE STRAIGHT INFLOW/ BIFURCATED OUTFLOW PATIENT LINE

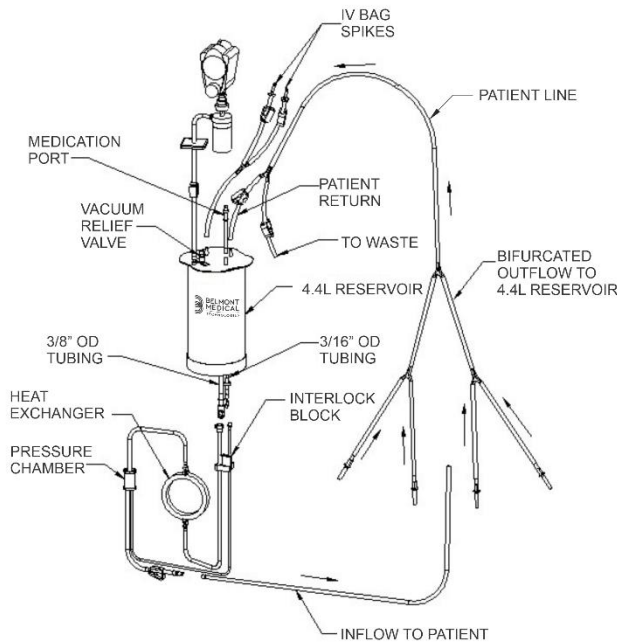

Straight Inflow/Outflow Patient Line Configuration with 4.4 Liter Reservoir, Heat Exchanger and Vacuum Regulator

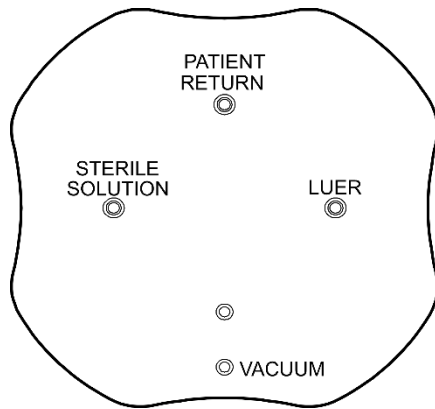

Reservoir Top View

4.4 Liter Reservoir with Straight Inflow/ Bifurcated Outflow Patient Line Version

1. Place the reservoir into the holder.
2. Assemble the reservoir, using aseptic techniques, as follows:

Top of Reservoir: Remove all vented caps from top of reservoir and install these parts to the marked locations:

- Bag Spike for STERILE SOLUTION
- Tubing with injection port to LUER
- Regulator source tubing from the vacuum trap to VACUUM

3. Using aseptic technique, connect the Reservoir outlet, 3/8" O.D tubing, and the Recirculation Line, 3/16" O.D tubing, to the connectors of the Heat Exchanger.
4. Adjust the Reservoir Holder to make sure that the two connection leads underneath the reservoir are not stretched or kinked.

Stretched or kinked connection leads can cause flow restrictions.

5. Close all clamps and the ON/OFF pinch clamps.

INSTALLING PATIENT RETURN LINE

1. Hand 8 ft. Patient Line and the 8 ft. Bifurcated Patient Line to the sterile field.
2. Receive both ends of the Patient Return Line from the sterile field.
3. Connect LUER end of the Patient Return Line to the LUER lock on the Heat Exchanger. Observe directional ARROW imprinted on the patient line.
4. Receive the "Y-Connection" end of the Bifurcated Outflow Patient Line from the sterile field and connect one end to top of the reservoir, marked PATIENT RETURN. The other end is used to remove waste at the end of the procedure. MAKE SURE THE ON/OFF PINCH CLAMP ON THIS LINE IS PINCHED CLOSED.

INSTALL 4.4 LITER RESERVOIR AND THE STRAIGHT INFLOW/OUTFLOW WITH (2) SUMPS AND (2) VIAGUARDS PATIENT LINE

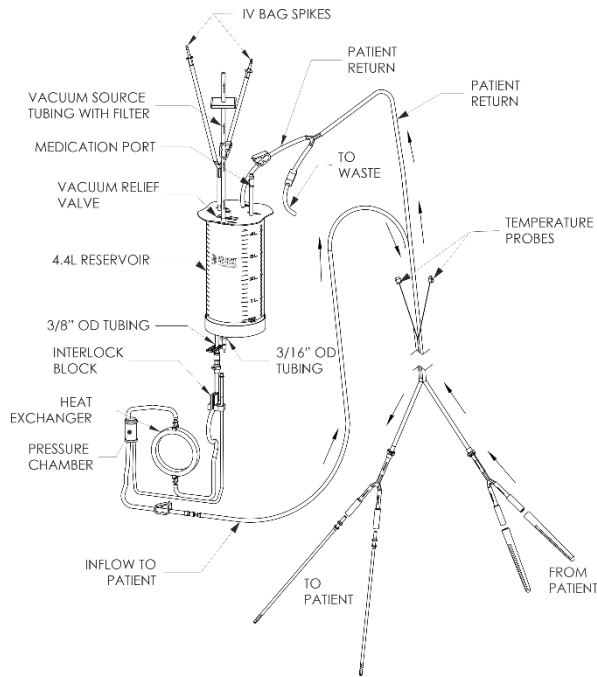

Two Inflow/Two Outflow with (2) internal Temperature Probes

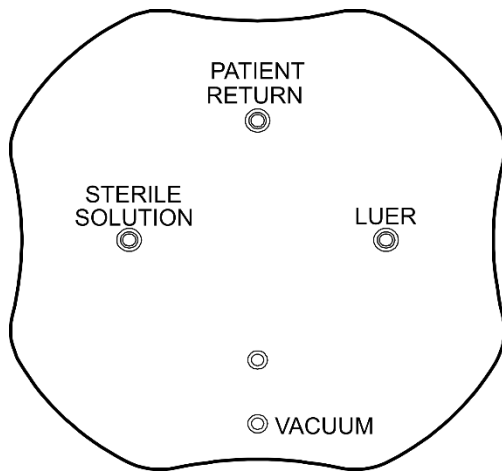

Reservoir Top View

The Hyperthermia Pump™ Procedure Kit

1. Place the reservoir into the holder.
2. Assemble the reservoir, using aseptic techniques, as follows:

Top of Reservoir: Remove all vented caps from top of reservoir and install these parts to the marked locations:

- Bag Spike for STERILE SOLUTION
- Tubing with injection port to LUER
- Regulator source tubing from the vacuum trap to VACUUM

3. Using aseptic technique, connect the Reservoir outlet, 3/8" O.D tubing, and the Recirculation Line, 3/16" O.D tubing, to the connectors of the Heat Exchanger.
4. Adjust the Reservoir Holder to make sure that the two connection leads underneath the reservoir are not stretched or kinked.

Stretched or kinked connection leads can cause flow restrictions.

5. Close all clamps and the ON/OFF pinch clamps.

INSTALLING PATIENT RETURN LINE

1. Hand off the Procedure Kit to the sterile field.
2. Receive both ends of the Patient Return Line from the sterile field.
3. Connect LUER end of the Patient Return Line to the LUER lock on the Heat Exchanger. Observe directional ARROW imprinted on the patient line.
4. Connect one "Y-Connection" end of the Patient Line to top of the reservoir, marked PATIENT RETURN. The other end is used to remove waste at the end of the procedure. **MAKE SURE THE ON/OFF PINCH CLAMP ON THIS LINE IS PINCHED CLOSED.**

POWER ON

- Check that the detachable power cable is securely seated in the main power receptacle.
- Check that the moisture guard is flush against the Hyperthermia Pump if present.
- Plug the system power cord into a grounded, 3-prong, 20 Amp, AC receptacle (120V device) or into appropriate grounded, 3-prong, minimum 10 Amp, AC receptacle (230V device) on a dedicated circuit breaker.
- Do not use an adaptor for ungrounded outlets.
- **Ensure that circuit breaker is easily accessible to turn off in an emergency situation.**
- Plug the external temperature interface cables to the Hyperthermia Pump™, labeled T1, T2, T3 and T4, as needed.

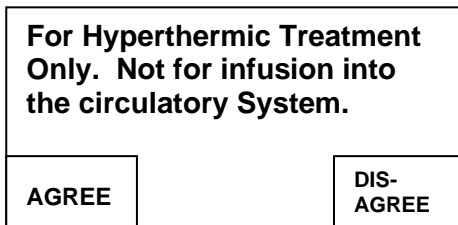

Power-Up Screen

1. Turn power on by firmly pressing the circuit breaker to the ON position. The system will perform a self-check to check the integrity of system parameters.
 - Belmont Logo with software revision and checksum appear.
 - Statement **“For Hyperthermic Treatment Only. Not for infusion into the circulatory system”** appears on screen. Check the power cord and AC receptacle connections if the statement does not appear.
 - If **“Agree”** is pressed, the screen will display “Password” screen. Enter a factory default password, **111111**.

NOTE: If “Disagree” is pressed, “Turn power off, procedure ended” will display.

- If you want to change the password (P.W), press “Change P. Word” and enter the old P.W. Enter the new P.W and then confirm the password by entering the new password.

CAUTION: The Hyperthermia Pump should be used by a trained professional only. The Hyperthermia Pump should not be left unattended while in operation.

WARNING: Use a dedicated circuit breaker for the Hyperthermia Pump. The Hyperthermia Pump has the potential to draw large current under normal operating conditions and should therefore be the only device operating on one circuit breaker. There is a risk of tripping the circuit breaker if multiple devices are connected to the same circuit breaker as the Hyperthermia Pump. Other outlets may be tied to the same breaker but NOTHING else should be plugged into those outlets during operation of the Hyperthermia Pump.

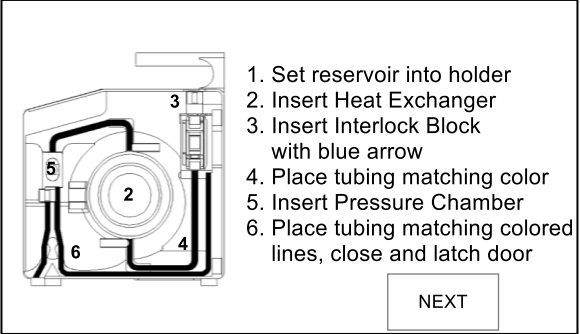
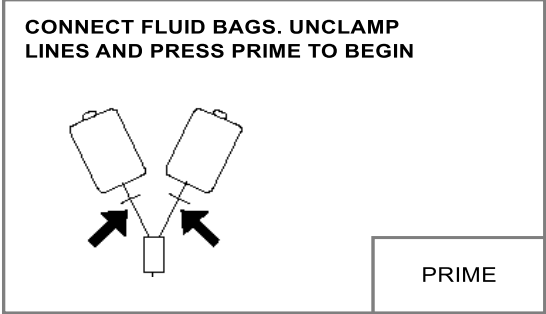
| | |
|---|--|
| <p>CHANGE LANGUAGE</p>  <p>1. Set reservoir into holder 2. Insert Heat Exchanger 3. Insert Interlock Block with blue arrow 4. Place tubing matching color 5. Insert Pressure Chamber 6. Place tubing matching colored lines, close and latch door</p> <p style="text-align: center;">NEXT</p> <p style="text-align: center;">Installation Screen</p> | <p>2. Press NEXT to go to the PRIME screen.</p> <ul style="list-style-type: none"> • If screen language is not your preferred language, turn power off and back on. • Press SERVICE to go to CALIBRATION/SETUP screen. • Press LANG SETUP → choose your preferred language → NEXT → EXIT SERVICE. • If you turn power ON without the disposable set, INSTALLATION screen appears. • Open the door and follow instructions on screen to install the disposable set. • Close the door. PRIME screen will automatically appear. |
| <p>INSTALLING FLUID BAG AND PRIME</p> <p>Sterile normal saline, peritoneal dialysis solution, or other crystalloid solution per physician order.</p>  <p>CONNECT FLUID BAGS. UNCLAMP LINES AND PRESS PRIME TO BEGIN</p> <p style="text-align: center;">PRIME</p> <p style="text-align: center;">Prime Screen</p> | <ol style="list-style-type: none"> 1. Hang (1) 2-liter sterile fluid bag on the IV pole. 2. Completely close bag clamps, remove the bag spike cap on the line closest to the user. Spike fluid bag, pierce it fully to ensure that fluids flow freely. 3. Open the clamps, on the line that pierced the sterile solution, and on reservoirs outlets (for Dual Reservoir version). 4. Drop sufficient volume to prime the entire system, approximately 500 ml. |

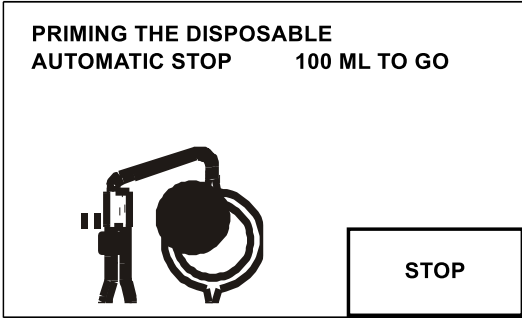
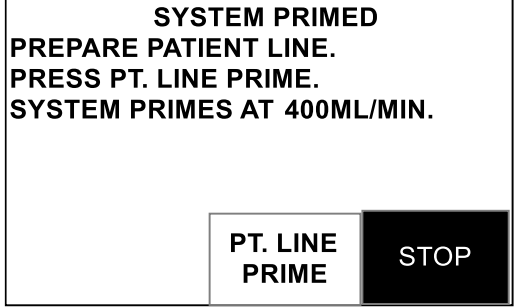
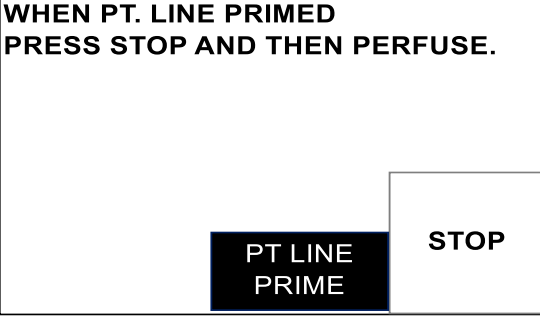
| | |
|--|---|
| <p>PRIME THE MAINE SYSTEM</p> <div data-bbox="284 231 803 546"> <p>PRIMING THE DISPOSABLE AUTOMATIC STOP 100 ML TO GO</p>  </div> <p>System Priming Screen</p> <p>CAUTION: Immediately wipe any spills from the device</p> | <ol style="list-style-type: none"> Press PRIME to recirculate 100 ml of fluid at 500 ml/min to remove air and fill the main system with fluid. The prime volume, 100 ml, countdown is displayed on the screen. The pump will stop automatically when countdown reaches 0 ml. If after 30 seconds and the prime volume remains at 100 ml, the system will stop, alarm and instruct the user to unclamp the lines and resume prime. If PRIME has to be stopped, press STOP. The prime volume countdown will remain on the screen. Press RESUME PRIME to continue prime. |
| <p>PRIME THE PATIENT LINE</p> <div data-bbox="292 787 803 1092"> <p>SYSTEM PRIMED PREPARE PATIENT LINE. PRESS PT. LINE PRIME. SYSTEM PRIMES AT 400ML/MIN.</p>  </div> <p>System Primed Screen</p> <div data-bbox="284 1186 820 1501"> <p>WHEN PT. LINE PRIMED PRESS STOP AND THEN PERFUSE.</p>  </div> <p>Patient Line Primed Screen</p> | <p>To remove air from the patient line.</p> <ol style="list-style-type: none"> Open the clamp, near the LUER end, and the ON/OFF pinch clamp on the patient line to the reservoir. Press PT. LINE PRIME. The system primes at 400 ml/min. Inspect to make sure that no air remains in the patient line. When air is no longer visible, press STOP. If there are air bubbles after the diversion valve, press PT. LINE PRIME again to remove air. <p>WARNING!</p> <p>Before continuing, you must inspect and make certain that the patient line is completely primed and free of air and the ON/OFF pinch clamp, on the waste line, is pinched closed.</p> |

| | |
|---|---|
| <p>CONNECT EXTERNAL TEMPERATURE PROBES.</p> <p>PROBES ARE SUPPLIED WITH THE PROCEDURE PACK KIT (REF 902-00045). IF YOU DO NOT USE THIS KIT (REF 902-00045), MAKE SURE YOU HAVE PROBES, IF NEEDED.</p> | <p>Accept external temperature connections from the sterile field and connect to the Hyperthermia Pump™ external temperature interface cables. Connect temperature probes to the corresponding color jacks on the unit. Push firmly to assure full contact. Forced mating of the connectors can cause malfunction and interruption of electrical continuity.</p> |
| <p>CONNECT TO THE PATIENT</p> | <ol style="list-style-type: none">1. Surgical personnel in sterile field cut the Patient Return Line to a specified length to accommodate the INFLOW and RETURN cannulation, except the Bifurcated Outflow version.2. Drop the prescribed solution to the reservoir.3. Inform surgical team that the prescribed solution is ready to ensure that only appropriate personnel are left in the room. |

INITIATING HYPERTHERMIC LAVAGE

WHEN PT. LINE PRIMED PRESS STOP AND THEN PERFUSE.

| | | |
|---------|----------------|------|
| PERFUSE | PT. LINE PRIME | STOP |
|---------|----------------|------|

Patient Line Primed and Infuse Screen

| | | | |
|--------|---|-----------------|------|
| ⊕ | T1 = 42.3°C | T2 = 42.0°C | |
| | T3 = 42.0°C | T4 = 42.0°C | |
| | RATE = 1000 $\frac{\text{ml}}{\text{min}}$ | Tpump = 42.0°C | |
| | VOL = 16.2 L | P = 125 mmHg | |
| RATE ▲ | 1000 $\frac{\text{ml}}{\text{min}}$ RATE | TARGET ▲ 42.5°C | STOP |
| RATE ▼ | | TARGET ▼ 42.5°C | |

Operation Screen

1. Press PERFUSE to start infusing at 10 ml/min.
2. Press 1000 ML/MIN key to pump at 1000 ml/min or adjust flow rate, as needed, by pressing RATE ▲/RATE ▼ key.
3. Adjust the output temperature from 37° to 48°C by pressing TARGET TEMP ▲/TARGET TEMP ▼ key to reach the specified output temperature.

The set temperature is displayed in both TARGET TEMP ▲ and TARGET TEMP ▼ keys. **The actual fluid temperature as it exits the heat exchanger, Tpump, is also displayed on screen.**

The Target Temperature is increased/decreased by 0.1°C every time key is depressed.

4. Pump the prescribed solution as directed by the surgeon. Adjust vacuum to facilitate fluid return (less vacuum – less return to reservoir).

MAINTAIN HYPERTHERMIC LAVAGE

| | | | |
|--|---|-----------------|-------------|
| ⊕ | | T1 = 42.3°C | T2 = 42.0°C |
| | | T3 = 42.0°C | T4 = 42.0°C |
| RATE = 1000 $\frac{\text{ml}}{\text{min}}$ | | Tpump = 42.0°C | |
| VOL = 16.2 L | | P = 125 mmHg | |
| RATE ▲ | 1000 $\frac{\text{ml}}{\text{min}}$ RATE | TARGET ▲ 42.5°C | STOP |
| RATE ▼ | | TARGET ▼ 42.5°C | |

Perfuse Screen

Routinely check patient and system parameters, on screen. Respond to and correct system alarms.

Spike additional sterile crystalloid solution, as needed, per the surgeon.

MAIN OPERATION SCREEN

- RATE The actual rate pumped.
- VOL The actual volume pumped.
- P The actual in-line pressure.
- RATE ▲ □ Press to increase the flow rate (by 10 ml/min). Press and hold to increase the rate more rapidly. The maximum rate is 1000 ml/min.
- RATE ▼ Press to decrease the flow rate (by 10 ml/min). Press and hold to decrease the rate more rapidly. The minimum flow rate is 10 ml/min.
- 1000 ml/min RATE Press to set the system to pump at 1000 ml/min.
- Tpump The actual fluid temperature as it exits the heat exchanger. The desired output temperature can be set using TARGET ▲/TARGET ▼ key.
- T1 Patient Temperature at location 1.
- T2 Patient Temperature at location 2.
- T3 Patient Temperature at location 3.
- T4 Patient Temperature at location 4.
- TARGET ▲ Press to increase the output temperature through the range of 37°C to 48°C. Increment by 0.1°C. Press and hold to increase temperature more rapidly.
- TARGET ▼ Press to decrease the output temperature through the range of 37°C to 48°C. Decrement by 0.1°C. Press and hold to decrease temperature more rapidly.
- STOP Temporarily halts pumping and heating. Status display continues to be active.

Chapter 2: Operation

| | |
|--|--|
| <ul style="list-style-type: none"> • Pressure Control <p>Regulate the pump speed to keep line pressure under the user-set pressure limit.</p> | <p>The pressure status line flashes and periodically beeps while the system is under pressure control.</p> <p>Pressure control is due mainly to the small orifice of the catheters or any occlusions in the line.</p> |
| <ul style="list-style-type: none"> • Vacuum Control <p>Vacuum should be set between –0 to –160 mmHg.</p> <p>Adjust Vacuum regulator, in-line with vacuum source, provides aid in increasing vacuum supplied to the reservoir and consequently increases return volume from the patient to the reservoir.</p> | <ul style="list-style-type: none"> ▪ To Increase Return Volume to Reservoir <p>Increase the vacuum to the reservoir by turning the vacuum regulator clockwise. The vacuum may only need to be applied for a short period of time.</p> <ul style="list-style-type: none"> ▪ To Increase Volume to Patient <p>Decrease volume in the reservoir and increase the amount of fluid in the patient by turning the vacuum regulator counterclockwise.</p> |
| <ul style="list-style-type: none"> • Automatic Air Purging <p>After every 2 liters of fluid pumped, the system automatically purges air from the system.</p> | <p>The RATE status line displays REMOVING AIR during this process. The volume readout (VOL) remains unchanged during automatic air purging and resumes counting when pumping resumes.</p> <p>If the flow rate is at or below 500 ml/min, the recirculate rate is temporarily set to 500 ml/min during automatic air purging. If the flow rate is above 500 ml/min, the recirculate rate is at the actual flow rate.</p> <p>When pumping resumes, the system returns to the previously set flow rate.</p> |
| <p>END OF PROCEDURE</p> <p style="text-align: center;">CAUTION:</p> <p>With fluid in the disposable set and the system not powered on, keep the patient line clamped closed when opening the door to prevent uncontrolled fluid flow.</p> <p>CAUTION: If the power switch is not turned to STANDBY, the unit will automatically switch to Battery Mode and will run for a short time before shutting off.</p> <p>In order to turn the unit back to ON, turn the power switch to STANDBY. Plug the unit in the AC outlet and wait approximately 20 seconds before turning the power switch to ON.</p> | <ol style="list-style-type: none"> 1. Stop pump. Close the clamp on the large reservoir outlet. 2. Increase vacuum but not more than -150 mmHg, as needed, to facilitate emptying the body cavity. 3. If total volume exceeds 4.4 liters, an alternate receptacle is required to empty the body cavity. Body cavity fluid can be disposed directly into the waste by opening the ON/OFF pinch clamp on the waste line. 4. When all volume is reclaimed, clamp off Patient Return Line and bag spikes. Inflow, return line, and external disposable temperature probes (if used) are handed off the sterile field in orderly fashion. Dispose according to hospital policy. 5. Turn circuit breaker (power switch) to STANDBY. 6. Clean and disinfect the system, vacuum regulator, vacuum trap, IV pole, and the Dual Reservoir Holder using 70% isopropyl alcohol. |

| | | | | | | | | | | | | | | | | | | | | | | | | | | | | | | | | | | | |
|---|-----------------------------------|-----------------|-------------|-------------|-------------|-------------|--|----------------------------|--------------|--------------|--|-----------------------------------|-----------------|-------------|---|------|-----------------|---|--|-------------|-------------|-------------|-------------|--|--------------------|--------------|--------------|--------|-----------------------------------|-----------------|-------------|--------|------|-----------------|---|
| <p>ACCIDENTAL POWER OFF</p> <table border="1" data-bbox="272 222 768 632"> <tr> <td colspan="2" style="text-align: center;">⊕</td> </tr> <tr> <td>T1 = 42.3°C</td> <td>T2 = 42.0°C</td> </tr> <tr> <td>T3 = 42.0°C</td> <td>T4 = 42.0°C</td> </tr> <tr> <td>RATE = 1000 $\frac{\text{ml}}{\text{min}}$</td> <td>T_{pump} = 42.0°C</td> </tr> <tr> <td>VOL = 16.2 L</td> <td>P = 125 mmHg</td> </tr> <tr> <td colspan="2">PLEASE STOP THE PUMP BEFORE TURNING THE POWER OFF. TURN THE CIRCUIT BREAKER BACK ON.</td> </tr> <tr> <td colspan="2" style="text-align: right;">POWER OFF</td> </tr> </table> <p>Circuit breaker was turned to STANDBY while pumping.</p> | ⊕ | | T1 = 42.3°C | T2 = 42.0°C | T3 = 42.0°C | T4 = 42.0°C | RATE = 1000 $\frac{\text{ml}}{\text{min}}$ | T _{pump} = 42.0°C | VOL = 16.2 L | P = 125 mmHg | PLEASE STOP THE PUMP BEFORE TURNING THE POWER OFF. TURN THE CIRCUIT BREAKER BACK ON. | | POWER OFF | | <p>If the circuit breaker was turned to the STANDBY position while the system is pumping, the system will stop pumping, alarm and display. This message is to protect the system from being accidentally powered down during a procedure.</p> <p>To power down the system, press POWER OFF key on screen.</p> <p>To continue with the procedure, turn the circuit breaker back to the ON position and resume operation.</p> | | | | | | | | | | | | | | | | | | | | |
| ⊕ | | | | | | | | | | | | | | | | | | | | | | | | | | | | | | | | | | | |
| T1 = 42.3°C | T2 = 42.0°C | | | | | | | | | | | | | | | | | | | | | | | | | | | | | | | | | | |
| T3 = 42.0°C | T4 = 42.0°C | | | | | | | | | | | | | | | | | | | | | | | | | | | | | | | | | | |
| RATE = 1000 $\frac{\text{ml}}{\text{min}}$ | T _{pump} = 42.0°C | | | | | | | | | | | | | | | | | | | | | | | | | | | | | | | | | | |
| VOL = 16.2 L | P = 125 mmHg | | | | | | | | | | | | | | | | | | | | | | | | | | | | | | | | | | |
| PLEASE STOP THE PUMP BEFORE TURNING THE POWER OFF. TURN THE CIRCUIT BREAKER BACK ON. | | | | | | | | | | | | | | | | | | | | | | | | | | | | | | | | | | | |
| POWER OFF | | | | | | | | | | | | | | | | | | | | | | | | | | | | | | | | | | | |
| <p>BATTERY OPERATION SCREEN</p> <table border="1" data-bbox="272 821 760 1220"> <tr> <td colspan="2" style="text-align: center;">⊕</td> </tr> <tr> <td>T1 = 42.3°C</td> <td>T2 = 42.0°C</td> </tr> <tr> <td>T3 = 42.0°C</td> <td>T4 = 42.0°C</td> </tr> <tr> <td>RATE = 50 $\frac{\text{ml}}{\text{min}}$</td> <td>BATTERY NO HEATING</td> </tr> <tr> <td>VOL = 16.2 L</td> <td>P = 125 mmHg</td> </tr> <tr> <td>RATE ▲</td> <td>50 $\frac{\text{ml}}{\text{min}}$</td> <td>TARGET ▲ 42.5°C</td> <td rowspan="2" style="background-color: black; color: white; text-align: center; vertical-align: middle;">STOP</td> </tr> <tr> <td>RATE ▼</td> <td>RATE</td> <td>TARGET ▼ 42.5°C</td> </tr> </table> <table border="1" data-bbox="280 1262 760 1640"> <tr> <td colspan="2" style="text-align: center;">⊕</td> </tr> <tr> <td>T1 = 42.3°C</td> <td>T2 = 42.0°C</td> </tr> <tr> <td>T3 = 42.0°C</td> <td>T4 = 42.0°C</td> </tr> <tr> <td>RATE = 50 $\frac{\text{ml}}{\text{min}}$</td> <td>BATTERY NO HEATING</td> </tr> <tr> <td>VOL = 16.2 L</td> <td>P = 125 mmHg</td> </tr> <tr> <td>RATE ▲</td> <td>50 $\frac{\text{ml}}{\text{min}}$</td> <td>TARGET ▲ 42.5°C</td> <td rowspan="2" style="background-color: black; color: white; text-align: center; vertical-align: middle;">MUTE</td> </tr> <tr> <td>RATE ▼</td> <td>RATE</td> <td>TARGET ▼ 42.5°C</td> </tr> </table> <p>Perfuse screen while in battery operation</p> | ⊕ | | T1 = 42.3°C | T2 = 42.0°C | T3 = 42.0°C | T4 = 42.0°C | RATE = 50 $\frac{\text{ml}}{\text{min}}$ | BATTERY NO HEATING | VOL = 16.2 L | P = 125 mmHg | RATE ▲ | 50 $\frac{\text{ml}}{\text{min}}$ | TARGET ▲ 42.5°C | STOP | RATE ▼ | RATE | TARGET ▼ 42.5°C | ⊕ | | T1 = 42.3°C | T2 = 42.0°C | T3 = 42.0°C | T4 = 42.0°C | RATE = 50 $\frac{\text{ml}}{\text{min}}$ | BATTERY NO HEATING | VOL = 16.2 L | P = 125 mmHg | RATE ▲ | 50 $\frac{\text{ml}}{\text{min}}$ | TARGET ▲ 42.5°C | MUTE | RATE ▼ | RATE | TARGET ▼ 42.5°C | <p>The system automatically switches to battery operation, if the AC power is interrupted. The system can operate in battery mode, for a very short period of time. The maximum flow rate is 50 ml/min. There is no heat in battery operation.</p> <p>Audible alarm sounds every 10 seconds, to alert user that the system is in battery operation and requires an intervention. Press MUTE to silence the alarm. All operating keys will not operate until MUTE key is pressed. Full safety monitoring remains active. If the system is not plugged back into the AC outlet, it stops after 90 seconds. If the system is plugged back into the AC outlet prior to 90 seconds, it automatically reverts back to the AC operation and the flow rate reverts back to the previous rate.</p> <p>The built-in rechargeable battery automatically charges whenever the system is connected to line power.</p> |
| ⊕ | | | | | | | | | | | | | | | | | | | | | | | | | | | | | | | | | | | |
| T1 = 42.3°C | T2 = 42.0°C | | | | | | | | | | | | | | | | | | | | | | | | | | | | | | | | | | |
| T3 = 42.0°C | T4 = 42.0°C | | | | | | | | | | | | | | | | | | | | | | | | | | | | | | | | | | |
| RATE = 50 $\frac{\text{ml}}{\text{min}}$ | BATTERY NO HEATING | | | | | | | | | | | | | | | | | | | | | | | | | | | | | | | | | | |
| VOL = 16.2 L | P = 125 mmHg | | | | | | | | | | | | | | | | | | | | | | | | | | | | | | | | | | |
| RATE ▲ | 50 $\frac{\text{ml}}{\text{min}}$ | TARGET ▲ 42.5°C | STOP | | | | | | | | | | | | | | | | | | | | | | | | | | | | | | | | |
| RATE ▼ | RATE | TARGET ▼ 42.5°C | | | | | | | | | | | | | | | | | | | | | | | | | | | | | | | | | |
| ⊕ | | | | | | | | | | | | | | | | | | | | | | | | | | | | | | | | | | | |
| T1 = 42.3°C | T2 = 42.0°C | | | | | | | | | | | | | | | | | | | | | | | | | | | | | | | | | | |
| T3 = 42.0°C | T4 = 42.0°C | | | | | | | | | | | | | | | | | | | | | | | | | | | | | | | | | | |
| RATE = 50 $\frac{\text{ml}}{\text{min}}$ | BATTERY NO HEATING | | | | | | | | | | | | | | | | | | | | | | | | | | | | | | | | | | |
| VOL = 16.2 L | P = 125 mmHg | | | | | | | | | | | | | | | | | | | | | | | | | | | | | | | | | | |
| RATE ▲ | 50 $\frac{\text{ml}}{\text{min}}$ | TARGET ▲ 42.5°C | MUTE | | | | | | | | | | | | | | | | | | | | | | | | | | | | | | | | |
| RATE ▼ | RATE | TARGET ▼ 42.5°C | | | | | | | | | | | | | | | | | | | | | | | | | | | | | | | | | |

CHAPTER 3: ALARMS AND TROUBLESHOOTING GUIDE

INTRODUCTION

This chapter describes possible causes for alarm messages with suggestions for corrective actions. When the Hyperthermia Pump™ recognizes a situation that is compromising effective infusing, it stops pumping, heating, moves the valve wand into recirculate position, displays alarm message, instructions for corrective measure, and sounds an audible alarm. To silence the alarm and return to normal operation, follow instructions on the screen.

A. OPERATIONAL ALARMS:

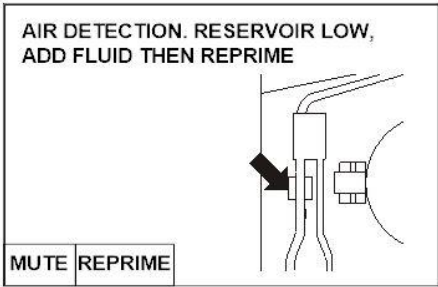
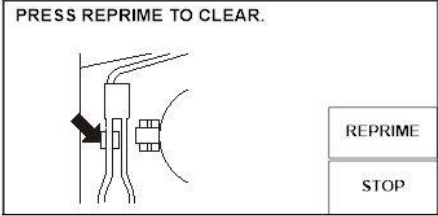
| ALARM MESSAGE | POSSIBLE CONDITION | OPERATOR ACTION |
|--|---|--|
| <p>AIR DETECTION</p>  <p>Air Detection Alarm Message Screen</p>  <p>Reprime Screen</p> | <p>Air in the line.</p> <p>Tubing in the air detection sensor is not seated firmly in the detector.</p> <p>Leak in the disposable.</p> <p>Air detector sensor dirty.</p> <p>Air detector electronics defective.</p> | <p>Press MUTE to silence the alarm.</p> <p>Check for air bubbles and possible leaks.</p> <p>Squeeze the tubing directly below air detector to clear any trapped air out of the sensor. There should be no trapped air remaining within the air detector.</p> <p>Check the air detector and make certain that it is clean and nothing is obstructing the sensor.</p> <p>Reseat the tubing in the air detector and make certain that it is seated firmly in the sensor. Press REPRIME to reprime main system fluid circuit.</p> <p>Power down and service the machine if error persists.</p> |

Chapter 3: Alarms and Troubleshooting Guide

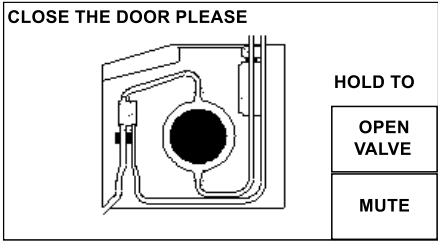
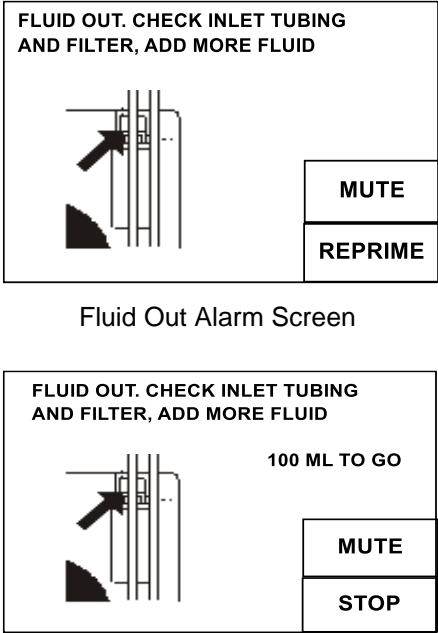
| ALARM MESSAGE | POSSIBLE CONDITION | OPERATOR ACTION |
|---|---|---|
| <p>DOOR OPEN</p>  <p>Door Open Alarm Screen</p> | <p>The door is open.</p> <p>No magnet in the door latch.</p> | <p>Close the door to silence the alarm and resume.</p> <p>Check magnet in the door latch.</p> <p>If the door is opened while the system is pumping, the system will immediately stop heating and pumping. The valve moves to the recirculate position and an audible alarm sounds.</p> |
| <p>FLUID OUT</p>  <p>Fluid Out Alarm Screen</p> <p>Fluid Out Message after Pressing REPRIME Screen</p> | <p>Out of fluid.</p> <p>Bag clamps not fully opened or fully spiked.</p> <p>Tubing in the Fluid out sensor is not seated firmly in the detector, or tubing is stretched or pulls away from the sensor, due to vacuum in the line.</p> <p>Clogged filter.</p> <p>Reservoir or recirculate line is obstructed.</p> <p>Vacuum source is set too high.</p> <p>Detector electronics defective.</p> | <p>Press MUTE to silence the alarm.</p> <p>If out of fluid, add additional fluid and press REPRIME.</p> <p>If the Reprime volume count does not count down from 100 to 0 ml, then:</p> <ul style="list-style-type: none"> • Check the bags are fully spiked and clamps are fully opened. • Check that the pump head tubing is not stretched and is seated firmly within the fluid out sensor. • Check the fluid out sensor and make certain it is clean and there is nothing obstructing contact with the sensor. • If there is fluid in the reservoir, check the vacuum source. Vacuum should not be more than 100 mmHg. <p>Reseat the tubing in the fluid out detector and make certain that it is seated firmly in the sensor.</p> <p>High amounts of particulates may clog the coarse filter in the reservoir. Replace the reservoir if it is clogged.</p> <p>Power down and service the machine if error persists.</p> |

Chapter 3: Alarms and Troubleshooting Guide

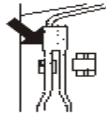
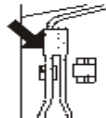
| ALARM MESSAGE | POSSIBLE CONDITION | OPERATOR ACTION |
|---|--|--|
| <p>HIGH PRESSURE</p> <div style="border: 1px solid black; padding: 5px; margin-bottom: 10px;"> <p>HIGH PRESSURE DETECTED CHECK PATIENT LINE FOR BLOCKAGE.</p>  <div style="float: right; text-align: center;"> <div style="border: 1px solid black; padding: 2px 5px;">MUTE</div> <div style="border: 1px solid black; padding: 2px 5px;">NEXT</div> </div> </div> <div style="border: 1px solid black; padding: 5px;"> <p>HIGH PRESSURE DETECTED CHECK RECIRC LINE FOR BLOCKAGE.</p>  <div style="float: right; text-align: center;"> <div style="border: 1px solid black; padding: 2px 5px;">MUTE</div> <div style="border: 1px solid black; padding: 2px 5px;">NEXT</div> </div> <p style="text-align: center;">High Pressure Alarm Screen</p> </div> | <p>Patient line is kinked or inadvertently clamped.</p> <p>Recirculate line is blocked.</p> <p>Inflow cannula is obstructed.</p> <p>Pressure limit setting is set too low.</p> | <p>Make certain that the flow path is not blocked.</p> <p>Check that the recirculate line is not obstructed.</p> <p>Check that the inflow cannula is not obstructed.</p> <p>Increase pressure limit setting.</p> <p>Press NEXT to silence the alarm and resume.</p> <p>Check functionality of the pressure transducer by gently pressing the transducer. Pressure reading on screen should change. If not, it is defective, service machine.</p> |
| <p>MISSING DISPOSABLE</p> <div style="border: 1px solid black; padding: 5px; margin-bottom: 10px;"> <p>*****MISSING DISPOSABLE*****</p> <p>OPEN DOOR TO SILENCE ALARM. INSTALL THE DISPOSABLE. CLOSE THE DOOR.</p> </div> <div style="border: 1px solid black; padding: 5px; text-align: center;"> <div style="border: 1px solid black; padding: 2px 5px; width: 50px; margin: 0 auto;">MUTE</div> </div> <p style="text-align: center;">Missing Disposable Screen</p> | <p>No disposable set in the unit.</p> | <p>Properly install disposable.</p> <p>Press NEXT to resume.</p> |

B. HEATING ALARMS:

| ALARM MESSAGE | POSSIBLE CONDITION | OPERATOR ACTION |
|--|--|--|
| <p>SYSTEM ERROR #101</p> <p>CHECK TEMPERATURE PROBES FOR BLOCKAGE. CLEAN WINDOWS. PRESS RETRY TO CONTINUE. SERVICE MACHINE IF ERROR PERSISTS.</p> | <p>Wet, dirty or blocked disposable set windows.</p> <p>Wet, dirty or blocked IR probe.</p> <p>IR probe failure.</p> <p>Heater fault</p> | <p>Check disposable set and flow path for occlusions. Make certain the windows on the disposable set and the IR probes are clean and dry. Clean surfaces with moistened soft cloth if necessary. Dry off surfaces before continuing.</p> <p>Press RETRY to continue.</p> <p>Power off and service machine if error persists.</p> |

Chapter 3: Alarms and Troubleshooting Guide

| ALARM MESSAGE | POSSIBLE CONDITION | OPERATOR ACTION |
|--|--|--|
| <p>SYSTEM ERROR #102 INFUSATE OVER TEMPERATURE. DISCARD DISPOSABLE AND BLOOD. RESTART SYSTEM WITH A NEW DISPOSABLE. SERVICE MACHINE IF ERROR PERSISTS.</p> | <p>Fluid supply is over the temperature limit.</p> <p>Temperature probes are wet, dirty, or blocked.</p> <p>Restricted flow or out of fluid.</p> | <p>Check disposable set and flow path for occlusions. Make certain the windows on the disposable set and the IR probes are clean and dry. Clean surfaces with moistened soft cloth if necessary. Dry off surfaces before continuing.</p> <p>Make sure bag clamps are open and flow is unimpeded. Make sure that the filter is not clogged. Add more fluid, if fluid out.</p> <p>Clamp off the bag spikes and patient line and remove disposable. Power off and restart system with a new disposable.</p> <p>Service machine if the problem persists.</p> |

C. HARDWARE ALARMS:

| ALARM MESSAGE | POSSIBLE CONDITION | OPERATOR ACTION |
|--|--|---|
| <p>SYSTEM ERROR #201 POWER OFF AND RESTART. SERVICE MACHINE IF ERROR PERSISTS.</p> | <p>Air detector failure</p> | <p>Power off and restart. Service machine if error persists.</p> |
| <p>SYSTEM ERROR #202 POWER OFF AND RESTART. SERVICE MACHINE IF ERROR PERSISTS.</p> | <p>Fluid out detector failure</p> | <p>Power off and restart. Service machine if error persists.</p> |
| <p>SYSTEM ERROR #203 PRESS RETRY TO CONTINUE. SERVICE MACHINE IF ERROR PERSISTS.</p> | <p>Excessive AC power line noise or internal failure</p> | <p>Press RETRY to try again.</p> <p>Power off and restart. Service machine if error persists.</p> |
| <p>SYSTEM ERROR #204 POWER OFF AND RESTART. SERVICE MACHINE IF ERROR PERSISTS.</p> | <p>Heater power feedback sense coil open.</p> <p>Power feedback circuit malfunction.</p> | <p>Power off and restart. Service machine if error persists.</p> |
| <p>SYSTEM ERROR #205 PRESS RETRY TO CONTINUE. SERVICE MACHINE IF ERROR PERSISTS.</p> | <p>Heater hardware fault</p> | <p>Press RETRY to try again.</p> <p>Power off and restart. Service machine if error persists.</p> |

Chapter 3: Alarms and Troubleshooting Guide

| ALARM MESSAGE | POSSIBLE CONDITION | OPERATOR ACTION |
|--|---|--|
| <p>SYSTEM ERROR #206 CHECK FOR BLOCKED AIR INTAKE. WAIT FOR THE SYSEM TO COOL. SERVICE MACHINE IF ERROR PERSISTS.</p> | <p>Power driver module overheating</p> | <p>Make certain that the fan air vents at the bottom of the machine are not blocked.</p> <p>Wait for unit to correct problem. Display will return to Infuse screen when the error clears.</p> <p>Press MUTE to silence the alarm.</p> <p>Power off and restart. Service machine if error persists.</p> |
| <p>SYSTEM ERROR #207 CHECK PUMP FOR BLOCKAGE. PRESS RETRY TO CONTINUE. SERVICE MACHINE IF ERROR PERSISTS.</p> | <p>Pump tubing is installed incorrectly.</p> <p>Pump failure</p> <p>Pump speed feedback encoder failure.</p> <p>Pump runs out of control or not at all.</p> | <p>Check that pump tubing is seated on the pump head correctly.</p> <p>Check that pump turns freely and the pump head is clean.</p> <p>Press Retry to try again.</p> <p>Power off and restart. Service machine if error persists.</p> |
| <p>SYSTEM ERROR #208 CHECK VALVE FOR BLOCKAGE. POWER OFF AND RESTART. SERVICE MACHINE IF ERROR PERSISTS.</p> | <p>Valve failure</p> <p>Valve position sensor malfunction</p> | <p>Check that the valve is not blocked.</p> <p>Power off and restart. Service machine if error persists.</p> <p>CAUTION: Keep the patient line clamped closed when opening the door to prevent uncontrolled fluid flow.</p> |
| <p>SYSTEM ERROR #209 CHECK FOR BLOCKED AIR INTAKE. WAIT FOR THE SYSEM TO COOL. SERVICE MACHINE IF ERROR PERSISTS.</p> | <p>Printed Circuit Board overheating</p> | <p>Make certain that the fan air vents at the bottom of the machine are not blocked.</p> <p>Wait for unit to correct problem. Display will return to Infuse screen when the error clears.</p> <p>Press MUTE to silence the alarm.</p> <p>Power off and restart. Service machine if error persists.</p> |
| <p>SYSTEM ERROR #210 POWER OFF AND RESTART. SERVICE MACHINE IF ERROR PERSISTS.</p> | <p>Internal computer malfunction</p> | <p>Power off and restart. Service machine if error persists.</p> <p style="text-align: center;">CAUTION:</p> <p>Keep the patient line clamped closed when opening the door to prevent uncontrolled fluid flow.</p> |

Chapter 3: Alarms and Troubleshooting Guide

D. TROUBLESHOOTING OTHER OPERATIONAL DIFFICULTIES

Problems may occur that are outside the surveillance system due to improper setup, faulty accessory equipment, or internal failure of a component. Table below describes several of these potential problems, the alarm that might be generated (if any), and the corrective actions to take.

| PROBLEM | POSSIBLE CONDITION | OPERATOR ACTION |
|--|---|--|
| Battery No Heating, No power | Power cord not plugged in AC power. | Plug into AC receptacle; check power cord connection. Change AC power source. Keep the system plugged in to charge the battery. |
| Dim display | Display brightness in Setup Routine has been turned down to the lowest brightness setting. | Increase display brightness in System Setup, Chapter 4, page 40. |
| Flow rate is slowing down or will not go at the set rate | The system is keeping the pressure in the line under the Pressure Limit by reducing the infusion rate. | Check and remove kinks or obstructions in the tubing. Increase flow by increasing the Pressure Limit. Change the Pressure Limit in Calibration/Setup to a higher limit (maximum Pressure Limit is 300 mmHg), Chapter 4, page 40. |
| Keypad does not accept input | The keypad is being continually depressed. Keypad failure | Release the keypad and the constant beep will cease. If the alarm persists, power down and service machine. |
| Keypad is too sensitive or not responsive | Keypad sensitivity in Setup Routine has been set at Fast or Slow. | Reset keypad sensitivity in System Setup, Chapter 4, page 40. |
| No message, beep tone | Power switch not completely depressed or membrane switch failed. | Depress power switch completely. If problem persists, replace the membrane switch. |
| Power off immediately after switch to ON. System turns on for 2-3 seconds, then turn off automatically. | IGBT's on Driver 'A' and 'B' shorted. EPROM is not seated in the socket properly. | If the problem persists, power down and service machine. Service machine. |

Chapter 3: Alarms and Troubleshooting Guide

| PROBLEM | POSSIBLE CONDITION | OPERATOR ACTION |
|---|--|--|
| Pump is running too loud | Roller pump is hitting the door or pump tubing is not properly installed. | <ol style="list-style-type: none"> 1. Open the door and reinsert the pump tubing. 2. Check to make sure that there is no blood or debris around the door hinges causing the door to lift up resulting in the roller pump hitting the door hub. |
| System does not heat to physiologic temperature | <p>Windows on the disposable or IR sensor is wet or dirty.</p> <p>Power module is not calibrated properly.</p> <p>Power module malfunction or temperature probes are out of calibration.</p> | <p>Examine the windows on the disposable set for wetness or contaminants.</p> <p>Clean IR sensor window with soft cloth and alcohol if necessary.</p> <p>Service machine if problem persists.</p> |
| Unable to turn the system off | One of the components on Daughter Board failed. | Service machine. |

CHAPTER 4: PARAMETERS SETTING AND PREVENTIVE MAINTENANCE

INTRODUCTION

The Hyperthermia Pump™ requires minimal service and care. Preventive maintenance should be performed regularly to optimize performance and reduce the likelihood of downtime. Listed below are routine maintenance (as needed), periodic maintenance (at least once a year), and parameters setting. The instrument does not need regular calibration.

WARNING!

Practice standard precautions when handling any caustic solution.
Clean up all spills immediately.

WARNING!

Test leakage current routinely to insure against electrical shock hazard.

CAUTION:

Turn the system to STANDBY and unplug the power cord before cleaning to avoid electric shock.

CAUTION:

Immediately wipe any spills from the device.

WARNING!

Do not access system parameters setup while the instrument is patient connected.

Chapter 4: Parameters Setting and Preventive Maintenance

A. SYSTEM SETUP

Changes in system setup can be made to:

1. **Date and time:** Set the real time clock and date.
2. **Key Rate:** Set touch key sensitivity.
3. **Pressure limits** for High Pressure alarm: Set the maximum allowable in-line pressure. The possible setting ranges from 100 - 300 mmHg.
4. **Display brightness:** Change the display brightness.
5. **Language Setup:** Change screens to preferred language.

Parameter Setup changes are performed in the Service mode.

| | |
|---|---|
| Rev CKSUM= Belmont INSTRUMENT CORPORATION AC POWER PRESENT | For Hyperthermia Treatment Only. Not for infusion into the circulatory System. |
| <div style="border: 1px solid black; padding: 2px; display: inline-block;">SERVICE</div> | <div style="display: flex; justify-content: space-around; margin-top: 10px;"> <div style="border: 1px solid black; padding: 2px 10px;">AGREE</div> <div style="border: 1px solid black; padding: 2px 10px;">DIS- AGREE</div> </div> |

Pressing the SERVICE key accesses the Calibration/Set-up mode. This key appears on the BELMONT logo screen only at system powered-up. This screen remains active for 4.5 seconds before the system enters the Prime mode.

| | | | |
|--------------------------------|---------------|-------------------|-----------------|
| CALIBRATION/SET-UP | | | |
| TIME 23:59 | | DATE: 08-29-15 | |
| PRESS LIMIT 300mmHg | | | |
| AC POWER PRESENT (60Hz) | | | |
| | | DISPLAY BRIGHT | LANG. SETUP |
| TEMP CAL | PRESS CAL | POWER CAL | FAST KEYRATE |
| PRESS LIMIT | HARD- WARE | DATE TIME | EXIT SERVICE |

Chapter 4: Parameters Setting and Preventive Maintenance

1. Date/Time

Press DATE TIME in the CALIBRATION/SET-UP screen to set the time and date. Press either the TIME or DATE key.

| | | | |
|------------|---------------|------|------|
| TIME HH:MM | DATE MM-DD-YY | | |
| | | TIME | DATE |
| | | NEXT | |

Screen after pressing DATE TIME key

A numerical keypad will be displayed. Enter the appropriate time or date information. Enter the appropriate time in 24-hour clock format (i.e. 1:00 PM = 13:00). CANCEL will erase the entered value and return to the previous Date Time screen. Press UPDATE to save the new value and return to the previous DATE TIME key screen. **Press NEXT to return to the Calibration/Set-Up screen.**

| | | | |
|---------------|---|---|--------|
| DATE MM-DD-YY | | | |
| 1 | 2 | 3 | |
| 4 | 5 | 6 | |
| 7 | 8 | 9 | CANCEL |
| | 0 | | UPDATE |

Screen after pressing DATE

| | | | |
|------------|---|---|--------|
| TIME HH:MM | | | |
| 1 | 2 | 3 | |
| 4 | 5 | 6 | |
| 7 | 8 | 9 | CANCEL |
| | 0 | | UPDATE |

Screen after pressing TIME

Chapter 4: Parameters Setting and Preventive Maintenance

2. Display Brightness

There are four (4) levels of display brightness. Press DISPLAY BRIGHT to change the present level of brightness to the next level.

3. Language Setup

Press this key to set screens to your preferred language.

4. Key Rate

The key rate sets up the sensitivity of the touch keys. There are three different levels of sensitivity: FAST, MEDIUM and SLOW. The current level of sensitivity is indicated on the key itself. The FAST setting requires the least amount of time for a key to respond. The MEDIUM setting requires more time and the SLOW key requires the most time and makes the touch keys least sensitive. **The key sensitivity is set at factory to Medium.**

Note that this key changes the time required to depress a key for stroke to be recognized. The pressure required is not affected.

5. Pressure Limit

The user can set the maximum allowable in-line pressure. The possible setting ranges from 100 to 300 mmHg. The current pressure limit value is displayed on the PRESS LIMIT status line on the Calibration/Set-Up screen. Press and hold the key to change the limit in increments of 50 mmHg. During infusion, the system keeps the pressure in the line under the pressure limit by reducing the infusion rate as the in-line pressure approaches the pressure limit. **The pressure limit is automatically reset to 300 mmHg each time that the system is powered on.**

Chapter 4: Parameters Setting and Preventive Maintenance

B. SERVICE AND PREVENTIVE MAINTENANCE SCHEDULE

Schedule 1

To be performed by either the Clinical User or a Biomedical Technician (BMET).

| Routine Maintenance | Interval | | |
|---|-----------------------------|----------------|-------------------|
| | Before or After Each Use | Every Month | Every 6 Months |
| 1. Clean and/or Disinfect Exterior, if necessary. | ● | | |
| 2. Clean Fluid Out and In-Line Air Detector. | ● | | |
| 3. Check the Power Cord. | ● | | |
| 4. Clean Temperature Probes | ● | | |
| 5. Check/Clean the Fan Guard. | | ● | |
| 6. Check/Clean the Vacuum Trap | | ● | |
| 7. Check the System Seal. | | | ● |
| 8. Check Instrument Door and Ceramic Disk. | | | ● |
| 9. Check Rubber Feet. | | | ● |

Schedule 2

To be performed by either a BMET or other qualified service personnel.

| Required Test/Verification | Interval | |
|--|-------------------|---------------|
| | Every 6 Months | Every Year |
| 1. Perform Visual Inspection. | ● | |
| 2. Perform System Operational Check-Out, including the Audible Alarm Test. | ● | |
| 3. Perform Electrical Safety Test. | | ● |
| 4. Hardware Verification. | | ● |
| 5. Clean Pump Head | | ● |

C. ROUTINE MAINTENANCE

1. Clean and/or Disinfect Exterior

Clean the outside surfaces of the system and inside the door after each use.

- a. Turn the pump to STANDBY and unplug the power cord.
- b. Wipe the surface with a cloth moistened with water or isopropyl alcohol.

Note: Avoid the use of acetone or other solvents that might damage the surface.

- c. Also clean around the door hinges, making sure the door is pushed all the way down inside the hinges.
- d. Do not spray cleaning liquids into or onto the air vents at the bottom of the system.

2. Fluid Out and In-Line Air Detectors

Keep the fluid out and air detectors clean and dry. If they become dirty or wet, clean with a moistened Q-tip and dry. Air detector surfaces are delicate. Use care when carrying out this procedure.

3. Power Cord

Inspect the power cord along its length and connectors for cuts and breaks. Replace power cord if damaged.

4. Temperature Probes

Keep the probe sensors clean and dry. If they become dirty or wet, clean with a moistened Q-tip and dry. Use care not to damage the sensor surface.

5. Fan Guards

Inspect the fan guards, on the bottom of the unit, for debris that might impede air flow. Remove guards by unscrewing the 4 retaining screws and clean, with soap and water, if necessary. Make certain the guards are not damaged. Let the fan guards dry before reinstalling.

6. Vacuum trap

Inspect the vacuum trap. If there is contamination, remove the trap by turning the friction nut counterclockwise. Clean the interior surfaces using soap and water. Dry and re-assemble.

7. Seals

Inspect the seal around the unit to make certain it is in good condition. Check also the seal around the touch screen and ceramic disks. Use Dow Corning 732 multipurpose RTV sealant or equivalent if needed to maintain fluid resistance.

8. Instrument Door and Ceramic Disks

The instrument door must fit properly for the system to operate correctly. The platen part of the roller pump is located on the door. The platen must line up properly with the pump.

- a. Check hinges for debris build-up, clean any dried debris/fluid from hinges area. Be sure that door is seated completely down on the hinges.
- b. Check plastic rivets and door integrity. Make sure that the doorframe is not bent. Replace, if bent.
- c. Inspect the ceramic disks on the door and in the center of the unit for cracks. Return to manufacturer for replacement if they are damaged.

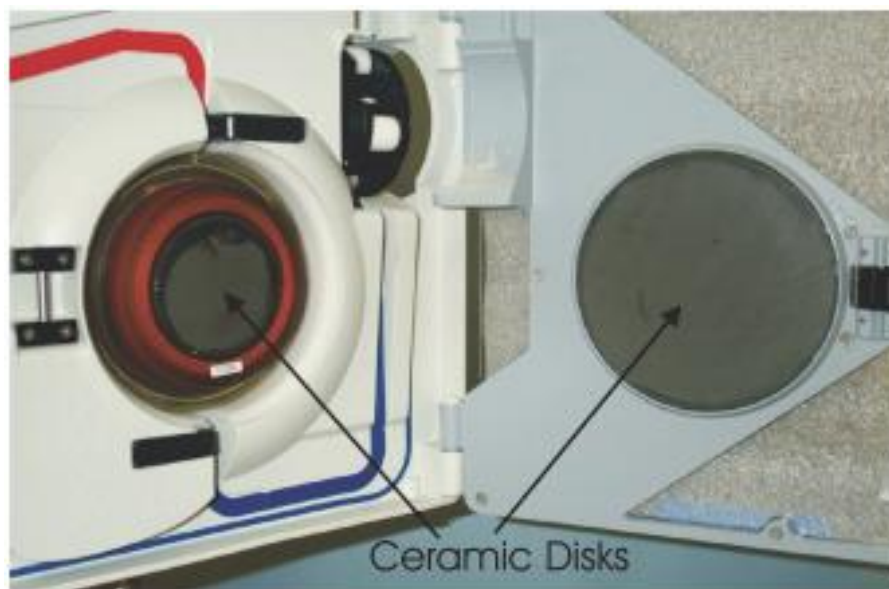

9. Rubber Feet

Inspect the rubber feet on the bottom of the unit for cracked or missing rubber feet. Replace if necessary.

D. TEST/SYSTEM OPERATIONAL CHECK-OUT

The device should be serviced periodically, in accordance to schedule 1 and 2, by a qualified technician.

Material Required:

- 3-Spike Disposable Set, REF 903-00006
- Safety Analyzer or equivalent
- Saline or other crystalloid for testing
- 2 liters of 35-42° C fluid
- Manometer (2 mmHg resolution)
- Pressure source
- Digital Thermometer with thermocouple (0.1°C resolution)
- Graduated cylinders (ASTM Class B accuracy)
- Timer
- Tachometer (optional)
- Hospital supplied vacuum source or vacuum pump

1. Visual Inspection

- a. Door Open/Right Hand Side:
 - i. Check that air and fluid out detectors are clean.
 - ii. Check that all the plastic push pins on the door are in-place.
 - iii. Check that the valve pincher set screw is tight.
 - iv. Check that there are no cracks in the ferrite on either the door or the right-hand side.
 - v. Check that the pressure transducer diaphragm has no tears or rips.
 - vi. Check that each pump roller spins freely. If not, remove and clean.
 - vii. Check that the door is pushed all the way down and there is no dried debris or fluid inside or around the hinges.
- b. Back:
 - i. Check that the AC connector (IEC connector) is clean. If there is some saline residue, clean.
- c. Verify Latch/Unlatch Mechanism:
 - i. Check the rubber pads on the pole clamp assembly. If they feel smooth, clean and scrub with isopropyl alcohol.
 - ii. Mount and un-mount the system on an IV pole, verify that the latch and unlatch work properly and the system will not move down the pole unexpectedly.

Chapter 4: Parameters Setting and Preventive Maintenance

2. System Operational Check-Out

- a. Install 3-Spike Disposable set, REF 903-00006.
- b. Turn power switch ON and agree to accept full responsibility at start-up sequence. Wait for PRIME screen to appear.
- c. Close bag clamps. Hang and spike fluid bag.
- d. Open bag clamp(s). Press PRIME to prime the system (circulate 100 ml of fluid at 500 ml/min.) Prime volume (100 ml) countdown is displayed on screen. Stop automatically when countdown reaches 0 ml.
- e. Press PT. LINE PRIME. Press STOP when line is free of air bubbles.
- f. Press PERFUSE to start pumping at 10 ml/min. Press RATE ▲▼ to change flow rate. Set the Target Temperature to 38°C.
- g. Increase flow rate to 500 ml/min and verify that the output temperature, on the display, is $38^{\circ} \pm 1^{\circ}\text{C}$.
- h. Remove the power cord. Verify that the system automatically switches to battery when AC is disconnected. BATTERY NO HEATING message displays to indicate the system is now in battery mode and heating is suspended. Verify that alarm sounds every 10 seconds. Press MUTE and STOP.
- i. Connect back to AC power and verify the operation is uninterrupted. Adjust the flow rate by pressing PERFUSE RATE ▲▼.
- j. Check the vacuum regulator:
 - i. Connect the vacuum source or the vacuum pump to the regulator inlet (behind the regulator);
 - ii. Connect draining tubing to the vacuum trap;
 - iii. Clamp the drain tube off, adjust the vacuum regulator knob;
 - iv. Verify that the indicator responds.

3. Electrical Safety Test - Leakage Current

Equipment required: Fluke Safety Analyzer, Model 505 or equivalent
2 Liters of room temperature saline

Setup: Plug the Hyperthermia Pump™ into AC outlet on the panel of the Safety Analyzer.

CAUTION:

Before applying voltage to Safety Analyzer, make sure input line voltage is correct for the **VOLTAGE OF UNIT UNDER TEST.**

Chapter 4: Parameters Setting and Preventive Maintenance

a. Earth Leakage Currents:

- i. Plug the Safety Analyzer into an appropriate power source, turn Analyzer power to ON. Hyperthermia Pump™ power switch to STANDBY.
- ii. Switch selector on Analyzer to CHASSIS or LEAKAGE (μA). Connect a single red lead to the SINGLE LEAD input jack and attach large clamp to equipotential ground terminal on the Hyperthermia Pump™.
- iii. Record the leakage current displayed for each of the following conditions, with Neutral switch in NORM position. Tests should be performed in the following order.
 - Polarity - NORM; Ground – NORM
 - Polarity - REVERSE; Ground – NORM
 - Polarity - REVERSE; Ground – OPEN
 - Polarity - NORM; Ground - OPEN
- iv. Repeat the first two (Normal Polarity and Reverse Polarity - Grounded) with Neutral switch in OPEN position.
- v. Install the disposable set and prime with saline and proceed to the Infuse screen. Press STOP to set the pump at 0 ml/min, not heating or pumping.
- vi. Repeat iii & iv with the Hyperthermia Pump™ in ON mode (power switch ON, infuse screen displayed, not pumping or heating).
- vii. Repeat iii & iv with the Hyperthermia Pump™ infusing and heating at 750 ml/min.
- vii. All measurements should be $<300 \mu\text{A}$ (for Domestic unit) and $<500 \mu\text{A}$ (for 230 V unit).

b. Patient Leakage Current:

- i. Install the disposable set and prime with saline and proceed to the Infuse screen.
- ii. Attach 12 to 16-gauge stainless steel cannula or hypodermic needle tip to the end of patient line and attach the Safety Analyzer large clamp to the cannula or needle tip.
- iii. Prime the Hyperthermia Pump™ with saline. Make sure that the entire patient line including the cannula has been primed.
- iv. Repeat a.iii, and a.iv with the Hyperthermia Pump™ in the STANDBY, ON, and pumping at 750 ml/min modes.

Chapter 4: Parameters Setting and Preventive Maintenance

- v. Maximum leakage allowable is as follows:

With NORMAL NEUTRAL

Normal Polarity - Grounded (10 μ A)

Reverse Polarity - Grounded (10 μ A)

Reverse Polarity - Not Grounded (50 μ A)

Normal Polarity - Not Grounded (50 μ A)

With OPEN NEUTRAL (Note: the system automatically switches to battery at 50 ml/min.)

Normal Polarity - Grounded (50 μ A)

Reverse Polarity - Grounded (50 μ A)

4. Hardware Verification

Properly install and prime the 3-Spike disposable set, REF 903-00006, before beginning the Hardware Verification process.

Hardware mode verifies:

- a. Valve operation
- b. Fluid Out and Air Detectors
- c. Battery voltage.
- d. Flow Rate (Pump speed)
- e. Input and Output Temperature Probes, and
- f. Pressure sensor.

A password is required to access the SERVICE screen, to ensure that this mode is not accessed accidentally.

Press the SERVICE key, at power-up, to access the Calibration/Set-up screen. This screen remains active for 4.5 seconds before the system enters the Prime mode screen.

WARNING!

Do not access hardware verification while the instrument is patient connected.

- Press HARDWARE from the Calibration/Set-Up screen.
- Enter the Password 013192.

Chapter 4: Parameters Setting and Preventive Maintenance

| | | | |
|--------------------------------|---------------|-------------------|-----------------|
| CALIBRATION/SET-UP | | | |
| TIME 23:59 | | DATE: 08-29-15 | |
| PRESS LIMIT 300mmHg | | | |
| AC POWER PRESENT (60Hz) | | | |
| | | DISPLAY BRIGHT | LANG. SETUP |
| TEMP CAL | PRESS CAL | POWER CAL | FAST KEYRATE |
| PRESS LIMIT | HARD- WARE | DATE TIME | EXIT SERVICE |

Calibration/Setup Screen

| | | | |
|---------------------------|-----------------------|------------------------|-----------------------|
| PUMP SPEED | | 0 | ml/min |
| INPUT | TEMPERATURE | 23.0 | (23.0) |
| OUTPUT | TEMPERATURE | 23.0 | (23.0) |
| PRESSURE | | 0 | mmHg |
| FLUID OUT DETECTOR STATUS | | AIR | |
| AIR DETECTOR STATUS | | AIR | |
| BATTERY VOLTAGE | | 28.5 | |
| BOARD TEMPERATURE | | 23 | C |
| | | | PUMP SPEED |
| LEFT VALVE | OPEN VALVE | RIGHT VALVE | CANCEL |

Hardware Status Screen

| Status Line | Reading |
|---------------------------|---|
| Pump Speed | 0, 10, 100, 500, 750 and 1000 ml/min |
| Input Temperature | Temperature in °C, probe ambient reference in parentheses |
| Output Temperature | Temperature in °C, probe ambient reference in parentheses |
| Pressure | Pressure in mmHg |
| Fluid Out Detector Status | Air or Fluid |
| Air Detector Status | Air or Fluid |
| Battery Voltage | Battery charge level in volts |
| Board Temperature | Temperature of the circuit board inside the case. |

Chapter 4: Parameters Setting and Preventive Maintenance

| Function Key | Action |
|--------------|---|
| PUMP SPEED | Change pump speed. |
| LEFT VALVE | Move the valve to the left or recirculate position. |
| OPEN VALVE | Move the valve to the middle or load position. |
| RIGHT VALVE | Move the valve to the right or infuse position. |
| CANCEL | Exit Hardware status and return to the Calibration/Set-Up screen. |

Hardware Verification:

a. Valve

- i. Press LEFT VALVE, confirm that the valve wand (valve pincher) moves to the left.
- ii. Press OPEN VALVE, confirm that valve wand moves to the middle position.
- iii. Press RIGHT VALVE, confirm that the valve wand moves to the right. Leave the valve in the LEFT VALVE position before continuing to the next step.

b. Fluid Out and Air Detectors

- i. Confirm that the Fluid Out Detector and the Air Detector status lines display FLUID when the system is primed, and no air is in the detectors.
- ii. Open the door and pull out the tubing from the detectors. Close the door and confirm that the status line display AIR when the tubing is removed from the sensor.

c. Battery Voltage

Unplug the unit from the wall outlet. 'Battery voltage' displayed in HARDWARE screen, should be approximately 24 volts. If not, recharge the battery for at least 8 hours and recheck. Plug the unit back into the wall outlet.

d. Flow Rate

The flow rate can be verified by actually measuring the flow using a graduated cylinder and timer or by using a tachometer. Choose the method that best serves your setup.

Chapter 4: Parameters Setting and Preventive Maintenance

Directly measure the flow:

- i. Make certain the patient line and entire disposable is fully primed before measuring. Set the pump speed to 10 ml/min. Press RIGHT VALVE to set the valve into the infuse position and fill the patient line. Use a graduated cylinder to measure flow at the patient line for ten minutes and verify the average flow rate over that period. The volume collected should be 100 ± 25 ml for an averaged flow rate of 10 ± 2.5 ml/min.
- ii. Press PUMP SPEED again to change the pump speed to 100 ml/min and measure the flow with a graduated cylinder for one minute. The accepted tolerance is 100 ± 10 ml/min.
- iii. Press once more to change speed to 500 ml/min and repeat the measurement. The accepted tolerance is 500 ± 50 ml/min.
- iv. Press once more to change speed to 750 ml/min and repeat the measurement. The accepted tolerance is 750 ± 50 ml/min.
- v. Press once more to change speed to 1000 ml/min and repeat the measurement. The accepted tolerance is 1000 ± 100 ml/min.

Measure by using a tachometer:

- vi. Close the door. Set the pump speed to 10 ml/min. Use a tachometer to measure the rotational speed of the pump head. The accepted tolerance is 1.95 rpm $\pm 25\%$.
- vii. Press PUMP SPEED again to change the pump speed to 100 ml/min. The accepted tolerance is 19.65 rpm $\pm 10\%$.
- viii. Press once more to change speed to 500 ml/min and repeat the measurement. The accepted tolerance is 97 rpm $\pm 10\%$.

e. Input and Output Temperature Probes

Prepare at least 2 liters of 37° - 43°C fluid.

- i. Connect the fluid supply to the disposable. Remove the patient line from the luer connector. Insert the thermocouple approximately 2" into the connector previously connected to the patient line.
- ii. Press the RIGHT VALVE key to set the valve to the infuse position. Open the fluid supply and set the pump speed to 500 ml/min.
- iii. Let the temperature stabilize, wait at least 2 minutes. The INPUT TEMPERATURE and OUTPUT TEMPERATURE value readings (the values not between the parentheses) should be within (2°C).
- iv. Compare the numbers displayed to the thermocouple reading. The accepted tolerance is 1°C for fluid temperature between 30°C to 40°C and 2°C outside this range.

Chapter 4: Parameters Setting and Preventive Maintenance

- v. Press PUMP SPEED to set the pump speed back to 0 ml/min.
- vi. Press CANCEL to return to the Calibration/Set-Up screen.

f. **Pressure Transducer**

WARNING!

Do not apply excessive pressure to the pressure chamber or pressure transducer. The pressure transducer is a precision electromechanical device and can be damaged with excessive force. **Do not use the system if the pressure transducer is damaged.**

- i. Inspect the pressure transducer for damage. Make certain the **surface of the transducer is not cut or punctured. The pressure transducer must be replaced if the surface is damaged.**
- ii. Make certain the pressure chamber is properly installed (see Chapter 2: Installing the Disposable) and the flow path is not blocked.
- iii. Make certain the fluid is warm (37°C - 42°C). The pressure chamber of the disposable is less compliant when it is at room temperature. **Verification must be performed with a warm disposable.**
- iv. In the Hardware mode: close the door, the bag clamps and block the air vent on top of the reservoir chamber. Disconnect the patient line and connect the pressure source to the LUER fitting at the patient line port of the disposable set and apply pressure while monitoring the amount of pressure with a manometer.
- v. Verify the accuracy of the pressure transducer. Apply 300 mmHg into the disposable. The pressure status line should read 300 mmHg (± 50 mmHg). Repeat the same pressure verification for 200 and 100 mmHg.

Chapter 4: Parameters Setting and Preventive Maintenance

5. Clean Pump Head

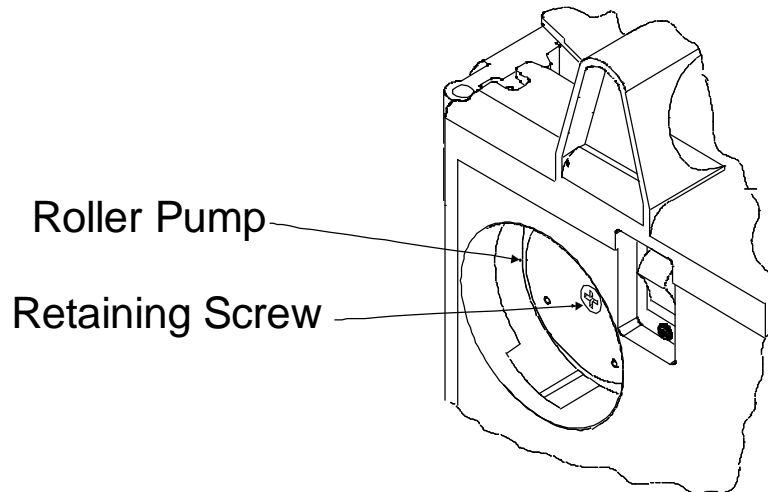

The pump head can be removed and cleaned if needed.

- a. Turn the pump to STANDBY and unplug the power cord.
- b. Unscrew the retaining screw that holds the pump head.
- c. Remove the pump head and clean with water and soap. Hydrogen peroxide or a mild bleach solution can be used to disinfect.
- d. Let pump head dry before replacing and make certain the pump head is securely fastened with the retaining screw.
- e. If the pump head squeaks, spray the roller with Silicone spray (Heavy Duty Pure Silicone.)

Chapter 4: Parameters Setting and Preventive Maintenance

E. CHECKLIST

| | | |
|-------------------------|------------|-------|
| Hyperthermia Pump™ S/N: | Tested By: | Date: |
|-------------------------|------------|-------|

| | | | |
|-----------------|----------------------|--|---------------|
| Equipment Used: | Safety Analyzer S/N: | | Cal Due Date: |
| | Pressure Source S/N: | | Cal Due Date: |
| | Thermometer S/N: | | Cal Due Date: |
| | Tachometer S/N: | | Cal Due Date: |

| | • Results | |
|--|-----------|---------|
| 1. Visual Inspection: a. Right Hand Side b. Back c. Latch/Unlatch | | √ if OK |
| 2. Operational Check-Out d. PRIME e. PT. LINE PRIME f. INFUSE ▲▼ g. Output Temperature @ 500 ml/min h. AC to DC switch over i. DC to AC switch j. Vacuum regulator | | √ if OK |
| 3. Electrical Safety Check (See attached Results Sheet) a. Earth Leakage Current b. Patient Leakage Current | | √ if OK |
| 4. Hardware verification: a. Valve Operation b. Fluid Out and Air Detectors c. Battery Voltage d. Flow Rate e. Input and Output Temperature Probes f. Pressure Sensor | | √ if OK |
| 5. Clean Pump Head | | √ if OK |

Chapter 4: Parameters Setting and Preventive Maintenance

Electrical Safety Test - Leakage Current Results Sheet

a. Earth Leakage Currents (all measurements are in μA)

| | Polarity - N; Ground - N | Polarity - R; Ground - N | Polarity - R; Ground - O | Polarity - N; Ground - O |
|---|-----------------------------|-----------------------------|-----------------------------|-----------------------------|
| Unit in STANDBY | | | | |
| ▪ Neutral - NORM | | | | |
| ▪ Neutral - OPEN | | | | |
| Unit in ON, not pumping | | | | |
| ▪ Neutral - NORM | | | | |
| ▪ Neutral - OPEN | | | | |
| Unit in ON, infusing @ 750 ml/min. | | | | |
| ▪ Neutral - NORM | | | | |
| ▪ Neutral - OPEN | | | | |

b. Patient Leakage Currents (all measurements are in μA)

| | Polarity - N; Ground - N | Polarity - R; Ground - N | Polarity - R; Ground - O | Polarity - N; Ground - O |
|---|-----------------------------|-----------------------------|-----------------------------|-----------------------------|
| Unit in STANDBY | | | | |
| ▪ Neutral - NORM | | | | |
| ▪ Neutral - OPEN | | | | |
| Unit in ON, not pumping | | | | |
| ▪ Neutral - NORM | | | | |
| ▪ Neutral - OPEN | | | | |
| Unit in ON, infusing @ 750 ml/min. | | | | |
| ▪ Neutral - NORM | | | | |
| ▪ Neutral - OPEN | | | | |

F. ELECTROMAGNETIC COMPATIBILITY

WARNING!

Medical Electrical Equipment needs special precautions regarding EMC and needs to be installed and put into service according to the Electromagnetic Compatibility [EMC] information provided in the accompanying documents.

WARNING!

Portable and Mobile RF Communications Equipment can affect Medical Electrical Equipment.

WARNING!

The equipment or system should not be used adjacent to or stacked with other equipment and that if adjacent or stacked use is necessary, the equipment or system should be observed to verify normal operation in the configuration in which it will be used.

NOTE: The EMC tables and other guidelines that are included in the Instruction Manual provide information to the customer or user that is essential in determining the suitability of the Equipment or System for the Electromagnetic Environment of use, and in managing the Electromagnetic Environment of use to permit the Equipment or System to perform its intended use without disturbing other Equipment and Systems or non-medical electrical equipment.

Chapter 4: Parameters Setting and Preventive Maintenance

| Table 201 | | |
|---|----------------------------|--|
| Guidance and Manufacturer's Declaration – Emissions All Equipment and Systems | | |
| The Hyperthermia Pump™ is intended for use in the electromagnetic environment specified below. The customer or user of the Hyperthermia Pump™ should assure that it is used in such an environment. | | |
| Emissions Test | Compliance | Electromagnetic Enforcement – guidance |
| RF Emissions CISPR 11 | Group 1, Class A | The Hyperthermia Pump™ uses RF energy only for its internal function. Therefore, its RF emissions are very low and are not likely to cause any interference in nearby electronic equipment. |
| Harmonics IEC 61000-3-2 | Complies or Not applicable | Complies |
| Flicker IEC 61000-3-3 | Complies or Not applicable | Complies |

| Table 202 | | | |
|---|---|---|--|
| Guidance and Manufacturer's Declaration—Immunity All Equipment and Systems | | | |
| The Hyperthermia Pump™ is intended for use in the electromagnetic environment specified below. The customer or user of the Hyperthermia Pump™ should assure that it is used in such an environment. | | | |
| Immunity Test | IEC 60601 Test Level | Compliance Level | Electromagnetic Environment - Guidance |
| Electrostatic Discharge (ESD) IEC 61000-4-2 | ±6kV contact ±8kV air | ±6kV contact ±8kV air | Floors should be wood, concrete or ceramic tile. If floors are synthetic, the relative humidity should be at least 30%. |
| Radiated RF IEC 61000-4-3 | 3 V/m | 3 V/m | Radiated RF frequency is negligible at any single frequency |
| Electrical Fast Transient/burst IEC 61000-4-4 | ±2kV on AC Mains | ±2kV on AC Mains | Mains power quality should be that of a typical commercial or hospital environment. |
| Surge IEC 61000-4-5 | ±1kV Differential ±2kV Common | ±1kV Differential ±2kV Common | Mains power quality should be that of a typical commercial or hospital environment. |
| Conducted RF IEC 61000-4-6 | 3 Vrms from 150 kHz to 80 MHz | V1 = 3 Vrms | If interference occurs, it may be necessary to position the Hyperthermia Pump™ further from sources of power frequency magnetic field. |
| Power Frequency 50/60Hz Magnetic Field IEC 61000-4-8 | 3A/m | 3A/m | Power frequency magnetic fields should be that of a typical location in a typical commercial or hospital environment. |
| Voltage dips, short interruptions and voltage variations on power supply input lines IEC 61000-4-11 | >95% Dip for 0.5 Cycle 60% Dip for 5 Cycles 30% Dip for 25 Cycles >95% Dip for 5 Seconds | >95% Dip for 0.5 Cycle 60% Dip for 5 Cycles 30% Dip for 25 Cycles >95% Dip for 5 Seconds | Mains power quality should be that of a typical commercial or hospital environment. If the user of the Hyperthermia Pump™ requires continued operation during power mains interruptions, it is recommended that the Hyperthermia Pump™ be powered from an uninterruptible power supply or battery. |

Chapter 4: Parameters Setting and Preventive Maintenance

G. FUSE

The fuse on the AC/DC supply marked F1 is rated as 1.25A, 250V, fast acting, 5x20mm with interrupting rating (breaking capacity) of 35A@250VAC.

H. CALL FOR SERVICE

USA: 855.397.4547

Worldwide: 1.978.663.0212

Prior to returning any product, please obtain a Return Merchandise Authorization (RMA) number.

Before calling, please have the serial number of the unit. The serial number is located on the label above the power receptacle.

CHAPTER 5: TECHNICAL SPECIFICATIONS

| DIMENSIONS | |
|-------------------|---|
| Size | 13.5" x 12" x 7.5" (34.29cm x 30.48cm x 19.05cm) |
| Weight | 28.5 lbs. (13.0 Kg) |

| PORTABILITY | |
|--------------------|---|
| Hand Carry | Handle on top of unit for easy transport |
| I.V Pole Mount | I.V pole mountable or free standing. I.V pole diameter range of pole mount: 1" - 1 1/4" |

| POWER AC | |
|-----------------------|---|
| AC Input Voltage | 115-120 V~ 20 amp dedicated or 230 V~ 10 amp dedicated |
| Fuse | 1.25A, 250V, Fast Acting, 5 x 20mm with interrupting rating (breaking capacity) of 35A@250VAC |
| Operating Frequency | 50/60 Hz |
| Maximum Power | 1440 VA |
| Line Isolation | 1500 V to ground |
| Earth Leakage Current | < 300 μ A (For Domestic unit) < 500 μ A (For 230 V \square unit) |
| Electrical Compliance | EN 60601-1, CSA/C22.2 - No. 601.1-M90 |
| Circuit Breaker | 15Amp, 125VAC/250VAC, 50/60 Hz |
| Power Cord | U.S.: 3 conductors, 14 AWG type SJT Cord with Hospital grade plug |
| | Outside U.S.: 3 x 1.5 mm ² International Harmonized Cordage with Hospital grade plug |
| BATTERY TYPE | |
| Running Time | Rechargeable lead acid Very short time without heat |
| Recharge Time | 8 hours |

Chapter 5: Technical Specifications

| ENVIRONMENTAL | |
|----------------------------|---|
| Operating Temperature | 10° C to 32° C (50° F to 90° F) |
| Storage Temperature | -15° C to 40° C |
| Relative Humidity | 10% to 90% |
| Pressure | 49-103 kPa |
| Shock and Vibration | Meet MIL STD.810E method 514.4 (Basic Transportation) |
| Electromagnetic Compliance | Meet EN60601-1-2 (2007) and IEC 60601-1-2 (2007) |

| OPERATING PARAMETERS | |
|-----------------------------|---|
| Flow Rate | 10 -1000 ml/min in 10 ml/min steps Tolerance: ± 10% from 20 - 1000 ml/min ± 25% for 10 ml/min |
| Output Temperature | User adjustable for target temperature of 37° C to 48° C |
| Heating Capacity | Min. 1400 watts to fluid (20° C temperature rise at 1000 ml/min) |
| Line Pressure | 0 - 300 mmHg, via pressure transducer |



| OPERATING PANEL | |
|---------------------------|---|
| Control Panel and Display | Splash proof touch screen display |
| Display Area | Diagonal screen 5.7" (14.5 cm) |
| Status Display | Flow rate (ml/min) Total volume infused (ml) Line pressure (mmHg) Output fluid temperature, T _{pump} (° C) Patient temperature @ location 1, T1 (° C) Patient temperature @location 2, T2 (° C) Patient temperature @location 3, T3 (° C) Patient temperature @location 4, T4 (° C) Target temperature (° C) Alarm messages |
| Functional Keys | Keys are displayed appropriate to the particular point in operation |
| Character Display | Graphical Alarm Messages - display where errors have occurred |





Chapter 5: Technical Specifications

| SAFETY AND MONITORING | |
|------------------------------|--|
| Infusate Temperature | Via infra-red sensors at the input and output to the heat exchanger. |
| Line Pressure | A pressure transducer monitors the in-line pressure. If the pressure reaches the threshold set by the user, the pump will slow down until pressure falls below the threshold. If the in-line pressure rises faster than 40 mmHg/ml or exceeds 400 mmHg, audible alarm sounds, the "HIGH PRESSURE" message is displayed, the line to the patient is closed and pump comes to an immediate stop. |
| Air Detection | <p>Two ultrasonic air detectors monitor air in the fluid path. The fluid detector is mounted closest the fluid bag. It sounds an alarm if there is no fluid entering the system. The other air detector checks for air in the fluid line before it enters the patient line.</p> <p>Out of Fluid criterion: Detect 0.8 ml air in input line</p> <p>Air detection criterion: Detect 0.1 ml air in fluid line</p> |
| Valve Wand | Provides flow path to patient, or recirculation fluid path within the system. The recirculation path is used to prime the system and eliminate air after an air detection alarm. The recirculation path is activated at all alarm conditions. |





| ALARM STATES AND CONTROLS | ALARM MESSAGES |
|------------------------------------|--|
| Operator Setting, User-correctable | MISSING DISPOSABLE DOOR OPEN FLUID OUT AIR DETECTION HIGH PRESSURE |
| Heating Alarms | SYSTEM ERROR #101 & 102 |
| Hardware Alarms | SYSTEM ERROR #201, 202, 203, 204, 205, 206, 207, 208, 209 & 210 |

Chapter 5: Technical Specifications

| CLASSIFICATIONS | |
|---|---|
| Type of Protection Against Electric Shock | Class I, or internally powered |
| Degree of Protection Against Electric Shock for applied part | CF defibrillator-proof at the end of patient line |
| Degree of Protection Against Harmful Ingress of Water | IPX2, Drip proof |
| Method of Sterilization | Ethylene Oxide. Disposable delivered sterile, with pyrogen-free flow path, for single use only. |
| Degree of Safety in Presence of Flammable Anesthetics | Not suitable |
| Mode of Operation | Continuous |
| Medical Equipment   | |

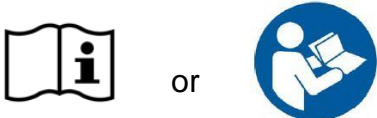
| SYMBOLS AND DEFINITIONS | |
|---|---|
| Symbol | Description |
|  | Compliance to Medical Device Directive 93/42/EEC and 2011/65/EU |
|  | Alternating current |
|  | Equipotentiality |
|  | Standby |
|  | ON |

Chapter 5: Technical Specifications

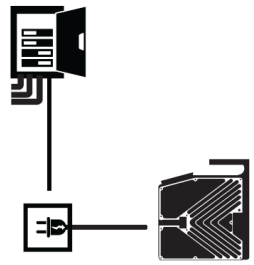
| | |
|---|--|
|  | Caution |
|  | Consult accompanying documents/refer to manual |
|  | Defibrillator-proof type CF equipment |
| IPX2 | Protected against dripping water |
| SN | Serial Number |
|  | Manufactured by |
|  | Authorized European Representative |
|  | Waste Electrical and Electronic Equipment |
|  | Dedicated Circuit Breaker |

Waste Electrical and Electronic Equipment (WEEE)

The crossed-out wheel bin symbol on the product, literature, or packaging reminds you that all electrical and electronic products, batteries, and accumulators must be taken to separate collection at the end of their working life. This requirement applies to the European Union and other locations where separate collection systems are available. To prevent possible harm to the environment or human health from uncontrolled waste disposal, please do not dispose of these products as unsorted municipal waste, but instead, hand in at an official collection point for recycling.